



SYSTEM MANUAL

LIVELINK



CONTENTS

Introduction	3		
Basic functions	3		
Safety instructions	3		
App download	3		
FAQ	3		
System overview	4		
LiveLink WiFi	5		
Push-button coupler	6		
Sensors	7		
· Technical Data	10		
· Sensor placement	12		
KNX Interface	13		
WI-FI	14		
· Connect to WI-FI	14		
· Utilising an existing WI-FI network	15		
· WI-FI security	15		
Access data	16		
Behaviour of light control	17		
· Behaviour in delivery condition	17		
· Behaviour in operation	17		
“LiveLink Install” app	22		
Overview	22		
What is a Use Case?	23		
· Public Use Cases	23		
· Private Use Cases	29		
· Universal Use Case	29		
Use Case management	30		
· Managing public Use Cases	31		
· Managing private Use Cases	32		
Room MANAGEMENT			33
· Room setup			34
· Room setup: Use Case			36
· Room setup: Assignment			40
· Room setup: Manage scenes			48
· Room setup: Setting up scenes			51
· Room setup: Assigning push-buttons			56
· Concluding the room setup			60
· Room management			61
· Room management: Rename room			62
· Room management: Basic lighting			64
· Room management: Set Up KNX			70
· Room management: Generate PDF			78
· Settings			80
· Settings: DALI fade time			81
· Settings: Reset LiveLink and hardware reset			81
· Settings: Advanced sensor settings			82
· Settings: Update firmware			84
· Settings: Change passwords			85
· WLAN settings			86
· WLAN settings:			
Connect to an existing local network			87
WLAN settings: WLAN deactivation			89
Operating the light control			90
“LiveLink Control” app			91
Overview			91
Select room			92
Manual setting of the room lighting			93
Activating lighting scenes			94
Order data			95

INTRODUCTION

BASIC FUNCTIONS

LiveLink is a light control system which offers automatic and/ or semi-automatic control for optimal quality and efficiency of illumination. The innovative operation via tables or smart phones provides maximum comfort for setup and operation.

LiveLink can be configured to meet all the client's requirements with a demand-oriented operation of luminaires. All luminaires and sensors which are connected must be equipped with a DALI interface (Digital Addressable Lighting Interface). Luminaires, sensors and push-buttons are connected per room to a LiveLink control device, whereby a room does not necessarily have to correspond to a physical room.

The system is setup via tablet and operated via tablet or smart phone. The highest security standards are also complied with (see chapter "Wi-Fi Security").

Connectivity to an existing network structure is possible.

Use Cases, which contain a pre-configuration of luminaire groups and light scenes are available to help set the system up. Through further configuration, each room can be individually set to meet their respective requirements.

SAFETY INSTRUCTIONS



- **Commissioning (electrical) must be carried out by an electrician.**
- **Work on electric devices may only be carried out when they are disconnected from mains power.**
- **Applicable safety and accident prevention regulations must be adhered to.**
- **Regarding installation, please adhere to the corresponding installation steps from the installation instructions of the luminaire to be installed.**

LiveLink is not intended for any application other than the one listed here. Other applications are considered to be in violation of the intended use. If LiveLink is used improperly, safe operation cannot be guaranteed.

APP DOWNLOAD

"LiveLink Install" app

The system is set up with the "LiveLink Install" app. The system prerequisite is a tablet with iOS 8 (or higher) or Android 4.1 (or higher).

"LiveLink Control" app

The "LiveLink Control" app provides for a comfortable operation of the room lighting. The system prerequisite is a tablet or smartphone with iOS 8 (or higher) or Android 4.1 (or higher).

FAQ

As well as this manual, the latest frequently asked questions (FAQs) and their answers are available at: www.trilux.com/livelink-faq



www.trilux.com/livelink-app



SYSTEM OVERVIEW

The LiveLink system has just a single hardware component, the LiveLink control device. Luminaires, sensors, push-buttons and/or push-button couplers are connected to the LiveLink control device via DALI.

In addition, LiveLink includes two software components: The "LiveLink Install" tablet app for the setup of the system by expert personnel and the "LiveLink Control" tablet and/or smart phone app for the control of the lighting installation by the end user.

The tablet and/or smart phone communicate directly with the control device which is equipped with its own Wi-Fi (access point) for this purpose, but, as an alternative, the LiveLink control device can also be integrated into an existing Wi-Fi network within the building.

The lighting can be controlled in two ways:

1. The activating of light scenes or switching and dimming of luminaire groups can be carried out with commercial push-buttons via the DALI installation. In addition, a push-button can be connected directly to the LiveLink control device.
2. Control via the "LiveLink Control" app. The app provides access to all light scenes and allows individual control of luminaire groups.

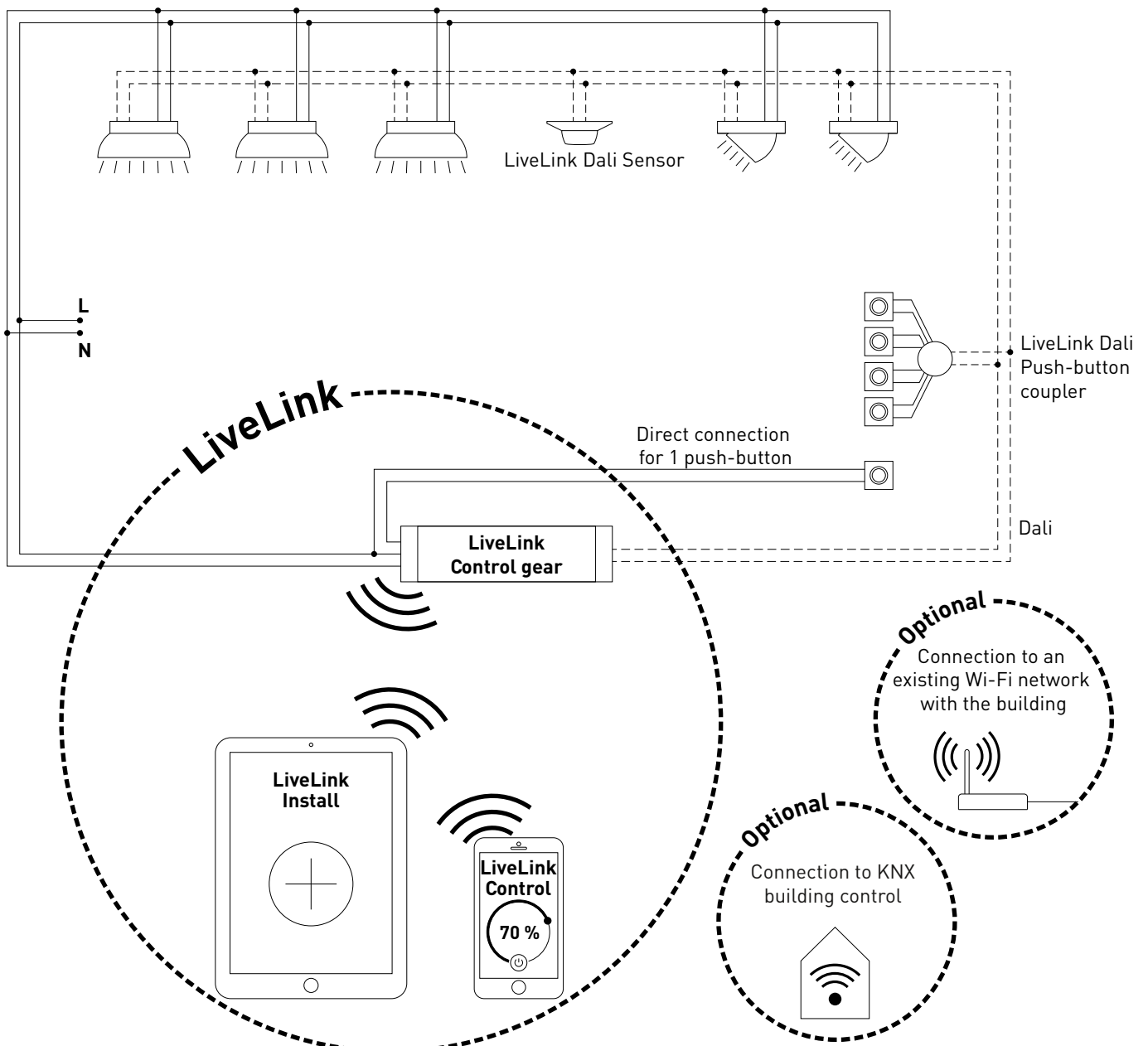

LIVELINK WIFI

The control device – the intelligent command centre.

The core element of the LiveLink control device is a Linux-based high-performance mini-computer which processes the incoming data streams and issues control commands to the system components. To make the communication with the installer as simple as possible, the control device is equipped with an integrated Wi-Fi module which can be controlled via tablet or smart phone.

Compact design – great flexibility

Thanks to its compact dimensions with a construction depth of just 22 millimetres, the control device can fit into shallow suspended ceilings without any problems. Also suitable for mounting on a DIN cap rail (TS35) with extra accessory. Upon request the control device can be integrated directly into a luminaire (master luminaire).

DALI interface for clever light management.

With the universal DALI interface, DALI-capable luminaires, sensors and push-buttons can be integrated, configured and controlled effortlessly. Each control device can individually address up to 16 luminaire groups. The maximum number of DALI members is 64.

Comfortable control via tablet or push-button.

The luminaires and/or groups of luminaires can be controlled either with a commercial installation push-button or via the app on a tablet or smart phone. Additional push-buttons can be connected via an optional LiveLink DALI push-button coupler that can be simply integrated into the DALI control circuit. The push-button can be configured freely – this way, "offline" groups of luminaires can be controlled too, or light scenarios called up.

Autarkic encryption for increased security.

To protect against external access, the control device is equipped with a Wi-Fi network with autarkic encryption. This way, the system remains unaffected by cyber attacks against the general computer network.

Configuration survives power outages.

No reprogramming is required after a power outage. The system configuration is stored in the control device so that the light management system is immediately fully operational again in the case of a restart.

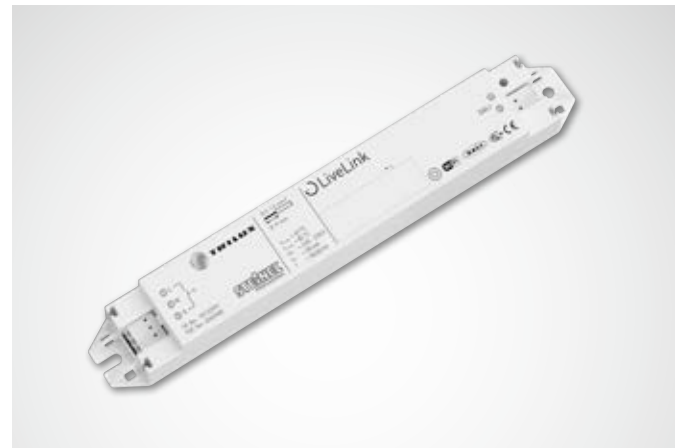

Technical Data

Weight	76 g
Input voltage	220-230 V
Input current	max. 50 mA
Input frequency	50/60 Hz
Standby power consumption	<2 W

Dimensions

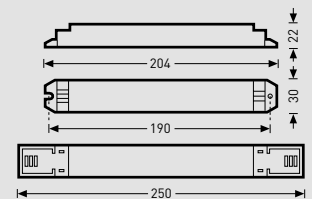

DALI members	max. 64
DALI output current	max. 128 mA
DALI groups	max. 16
Number of light scenes	max. 50
WiFi	IEEE 802.11b
WiFi encryption	WPA2
WiFi range	max. 25 m
Protection rating	IP20
Temperature of case tc max.	0-85 °C
Ambient temperature ta max.	0-65°C
Standards	IEC 61347-2-11 EN 55015 EN 61000-32 EN 61000-33 EN 61000-547 IEC 62386
Cable length for DALI	max. 300 m
Cable length for push-button	max. 25 m
Permissible cable cross-section	0,5 bis 1,5mm ²
TOC	6565200

PUSH-BUTTON COUPLER

Interface for commercial installation push-buttons

The push-button coupler integrates additional push-buttons into a LiveLink system. For this, up to 4 commercial installation push-buttons can be connected to each push-button coupler. The push-button coupler passes the signals on to the LiveLink control device via DALI. The function of the push-buttons is freely programmable during commissioning.

Fits into the flush device box

The compact dimensions allow for an installation in flush device boxes with a minimum depth of 60 mm. The push-button cables may have a maximum length of 25 m and must be installed in a separate plastic-sheathed cable. The connections at the push-button coupler are not suitable for mains voltage.



Technical Data	
Number of push-buttons	4
Cable length for push-button	max. 25 m
Number of DALI members	1
Dimensions	
TOC	6565200

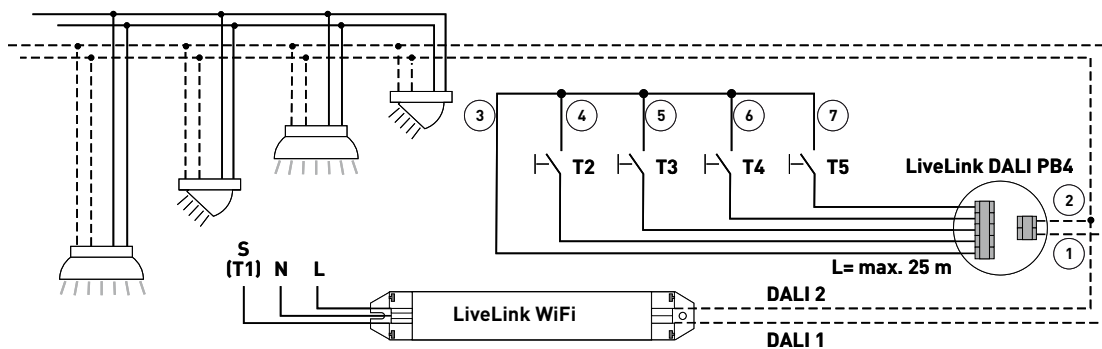

SENSORS

Any brain needs its sensory organs – and any light management system its sensors.

Light only when and where it is wanted and as bright as necessary. For a lighting control system to meet all the client's requirements, the framework conditions must be detected precisely. This task is handled by STEINEL's intelligent sensor technology.



IR Quattro HD
TOC: 6565500



Detects the most minute of movements all the way into any corner.

The infra-red presence detector IR Quattro HD is ideal for medium to large offices, conference rooms and meeting rooms as well as classrooms and lecture halls. Its high resolution detection is ideal in the case of sitting activities.

Equipment and functions:

- Highest quality of detection due to 4 pyro sensors with 4,800 switching zones per 64 m²
- Straight-forward planning with square detection area
- Quick setting due to patented mechanical scalability without loss of quality
- 8 x 8 metres presence detection, 8 x 8 metres radial detections and 20 x 20 metres tangential detection
- Suitable for ceiling heights from 2.5 up to 10 metres



IR Quattro Slim XS
TOC: 6906200



Compact dimensions and high performance – IR Quattro Slim XS.

Sensor technology is a must-have in many buildings today. Presence sensors, especially in offices and prestigious areas, should blend as discreetly as possible into the room. This is the ideal application for the IR Quattro Slim XS infrared presence sensor. With a construction height of just 4 mm the sensor installs almost flush to the ceiling, and is practically invisible for observers. A genuine highlight is the globally unique retina lens, enabling a square detection range of an astounding 16 square metres at an installation height of up to 4 metres, despite its flat construction design. The presence sensor even responds to motion hardly perceptible for the human eye thanks to its extremely high resolution and absolutely precise sensor technology.

Features and functions:

- Sensor blends discreetly into the room with a construction height of only 4 mm
- Suitable for ceiling heights of 2.5 to 4 metres
- PIR with retina lens and hexagonal Fresnel structure for large detection range
- Square detection zone (presence, radial, tangential) consists of 16 square metres
- High resolution, precise detection

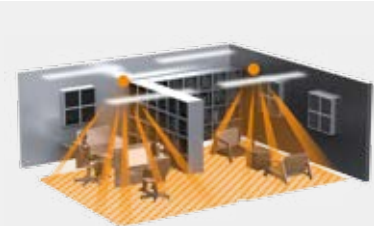

IR Micro embedded sensor

TOC: 6906300



Compact, integrated and with high-performance.

The IR Micro embedded sensor bundles outstanding sensor technology in a highly compact space. Equipped with a high-sensitivity pyrosensor and special lens, the miniature sensor quickly and reliably detects even the minutest movements. The sensor is so compact that it can be assembled into almost all TRILUX luminaires – and blends harmoniously into the luminaire design thanks to its discreet appearance. With a mounting height of up to 4 metres and a square detection range of 36 m² the IR Micro embedded sensor is ideal for use in offices and classrooms. A further benefit: because it is already integrated in the luminaire, no extra installation effort is necessary.



Features and functions:

- Miniature sensor for assembling in luminaires with almost all TRILUX product ranges
- High-sensitivity pyro-sensor with special lens for detecting the smallest of movements
- Mounting height of up to 4 m
- Square detection range of up to 36 m²
- No additional installation effort because the sensor is already built in to the luminaire

Dual HF

TOC: 6565600



Doubly convincing across the board.

The high frequency corridor sensor Dual HF, with its detection area of 20 x 3 metres, is suitable for long corridors. Decisive for a corridor sensor is how well radial movements are detected. This refers to the frontal direction of walking towards the sensor. The STEINEL high frequency technology masters this perfectly.

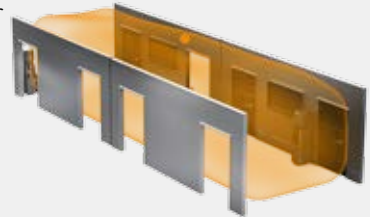

Equipment and functions:

- Two integrated HF sensors with dual directional characteristic for up to 20 metres of radial detection
- Detects equally well from any direction of walking
- Continuously variable, electronic setting

IS 3360 MX Highbay

TOC: 6781000



Higher, further, quicker.

The IS 3360 MX Highbay infrared motion sensor indoor and outdoor applications with a mounting height of up to 14 metres is ideal for detecting movement in high rooms and wide areas such as parking garages, underground garages, production or storage areas and dispatch halls. The IS 3360 MX Highbay infrared motion sensor achieves seamless all-round detection in rooms thanks to a 360° detection angle and aperture angle of 180°. It is equipped with three high-sensitivity pyro-sensors which register movements in a radius of up to 18 metres. Installation is very simple thanks to the generous connection space.

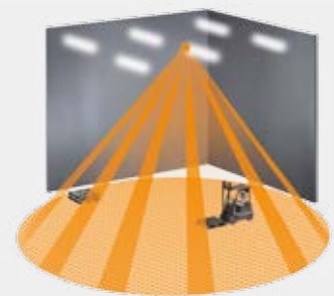

Features and functions:

- Sensor for ceiling mounting at heights of 3 to 14 metres
- Three pyro-sensors with a detection radius of max. 18 metres
- All-round detection via 360° detection angle and 180° aperture angle
- Simple installation thanks to generous connection space

IS 345 MX Highbay

TOC: 6781100

**Monitoring at the highest levels.**



The IS 345 MX Highbay infrared motion sensor for indoor and outdoor applications is ideal for high heights in e.g. warehouses, logistics halls and highbay racking areas. The sensor has a detection angle of 180°, a detection field of 30 x 4 metres (radial) and is equipped with a special optical system designed for high mounting heights of up to 14 metres. The generous connection space enables simple mounting.

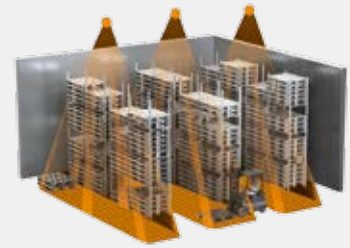

Features and functions:

- Special optical system enables mounting to ceiling heights of 4 to 14 metres
- Two pyro-sensors for radial detection of up to 30 x 4 metres at a 180° detection angle
- Simple mounting thanks to generous connection space

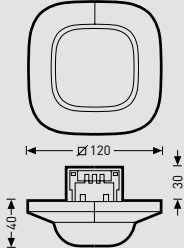
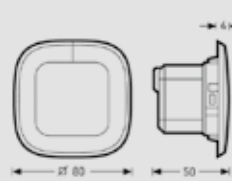
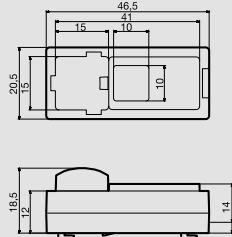
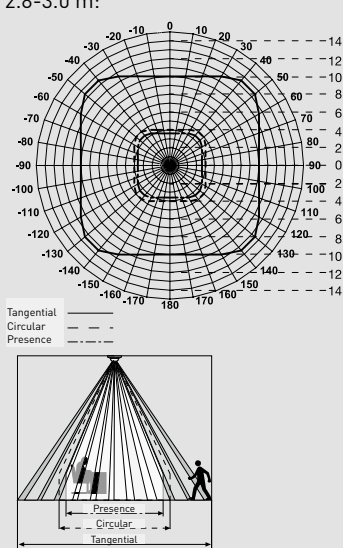
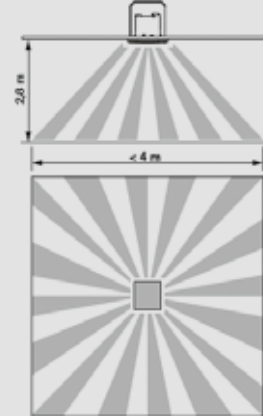
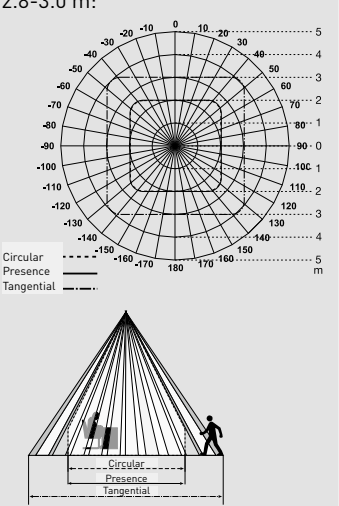

TECHNICAL DATA

Type	Quattro HD	IR Quattro Slim XS	IR Micro
			
Characteristics	<ul style="list-style-type: none"> • Square detection area typical for a room • Particularly high sensitivity and range 	<ul style="list-style-type: none"> • Room-typical square detection range • Flat design for almost ceiling-flush installation 	<ul style="list-style-type: none"> • Compact design for installation in luminaire or, optionally, in ceilings • Upon request, available installed in a LiveLink master luminaire
Function	<ul style="list-style-type: none"> • Presence • Constant light 	<ul style="list-style-type: none"> • Presence • Constant light 	<ul style="list-style-type: none"> • Presence • Constant light
TOC	6565500	6906200	6906300
Sensor type	Passive infrared (PIR)	Passive infrared (PIR)	Passive infrared (PIR)
Dimensions (H x W x D)			
Site of operation	In the interior area of buildings	In the interior area of buildings	In the interior area of buildings
Sensor system	4 pyro sensors with 13 detection levels, 4800 switching zones	High resolution pyro-sensor with special retina lens	High-sensitivity pyro sensor with special lens
Light value setting	10-1000 Lux	10-1000 Lux	10-1000 Lux
Protection rating	IP 20 (IP54 with AP Box)	IP 20	IP 20
Protection class	II	II	II
Temperature range	-20 °C to +55 °C	0 °C to +40 °C	0 °C to +40 °C
Number of DALI members	3	2	2
Height of installation (ceiling mount)	2.5 - 10 m	2,5 - 4,0 m	2.5 - 4.0 m
Detection angle/square	Presence: max. 8 x 8 m (64 m ²) Circular: max. 8 x 8 m (64 m ²) Tangential: max. 20 x 20 m (400 m ²)	Presence: max. 4 x 4 m (16 m ²) Circular: max. 4 x 4 m (16 m ²) Tangential: max. 4 x 4 m (36 m ²)	Presence: max. 4 x 4 m (16 m ²) Circular: max. 4 x 4 m (16 m ²) Tangential: max. 6 x 6 m (36 m ²)
Detection ranges	at an installation height of 2.8-3.0 m:	at an installation height of 2,8m:	at an installation height of 2.8-3.0 m:
			

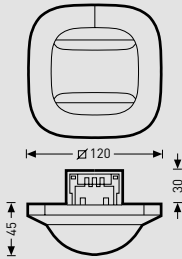
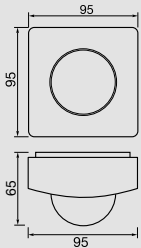
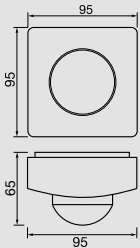
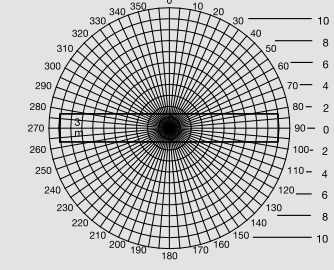
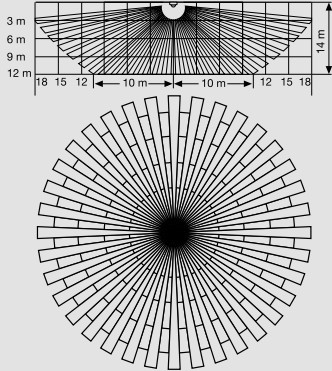
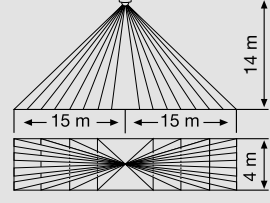
Type	Dual HF	IS 3360 MX Highbay	IS 345 MX Highbay
			
Characteristics	<ul style="list-style-type: none"> • Dual directional characteristic for targeted detection of hallways and corridors • Temperature-independent detection 	<ul style="list-style-type: none"> • For industry, production halls, warehouses • For high installation heights 	<ul style="list-style-type: none"> • For industry, production halls, warehouses • For high installation heights
Function	<ul style="list-style-type: none"> • Presence • Constant light 	<ul style="list-style-type: none"> • Presence 	<ul style="list-style-type: none"> • Presence
TOC	6565600	6781000	6781100
Sensor type	High frequency	Passive infrared (PIR)	Passive infrared (PIR)
Dimensions (H x W x D)			
Site of operation	In the interior area of buildings	In the interior area of buildings	In the interior area of buildings
Sensor system	High frequency 5.8 GHz, transmitting power < 1 mW	Three high-sensitivity pyro sensors with 360° detection angle and 180° aperture angle	Two pyro sensors with 180° detection angle
Light value setting	10-1000 Lux	-	-
Protection rating	IP 20 (IP54 with AP Box)	IP54	IP54
Protection class	II	II	II
Temperature range	-20 °C to +55 °C	-20 °C to +50 °C	-20 °C to +50 °C
Number of DALI members	8	3	3
Height of installation (ceiling mount)	2.5 - 3.5 m	3 - 14 m	4 - 14 m
Detection angle/square	see diagram; through glass, wood and lightweight partition walls if required; range max. 20 x 3 m (max. 10 x 3m in each direction), infinitely variable electronic setting	∅ max. 36 m	max. 30 x 4 m
Detection ranges	at an installation height of 2.8-3.0 m: 	at an installation height of 14 m: 	at an installation height of 14 m: 

SENSOR PLACEMENT

Detection area

- The detection area of the sensor must be taken into consideration (see sensor's product data sheet). On the one hand, the sensor should detect areas of work and movement in the room but, on the other, also the entrance so that the light can be switched on early. If the detection area is insufficient, additional sensors must be planned in.
- When using HF and/or radar sensors, it must be taken into consideration that a detection through thin walls may occur. In addition, the narrow detection area (see product data sheet) must be taken into consideration.

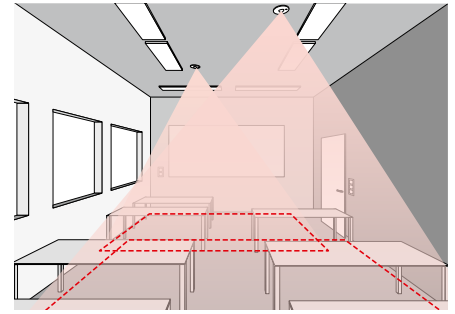

Light sensor

For the daylight control function, it is important that the light sensor and/or combined presence and light sensor be positioned in a suitable location.

- The light sensor should not be positioned too close to window areas but also not too far inside the room.
- The sensor should be positioned where it receives an average intensity of daylight, e.g. in the middle of the room or near work spaces to which the light control can be calibrated.
- If possible, the light sensor should be positioned above a suitable area. Ideally, this area should also be utilised as a reference area for the calibration of the illuminance. If possible, this area should feature an average reflectance value. Desk surfaces or light-grey path areas are particularly well suited to this.
- It should also be taken into consideration that no items be placed underneath the sensor that have an influence on the function of the light sensor, e.g. pallets or tall pieces of furniture.

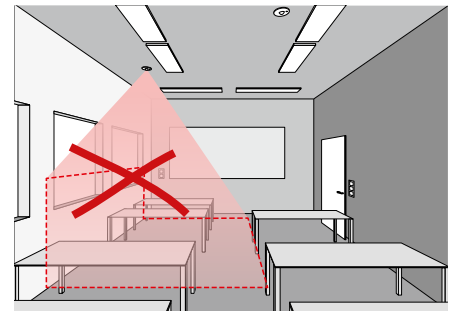

Sources of interference

Positioning near the following sources of interference should be avoided:

- Heat sources influence measurement by the passive infrared sensors (PIR). Maintain sufficient distance to the heat sources. Typical examples are fan heaters, open doors and windows, pets, light bulbs/halogen spotlights and moving objects.
- Interference sources of light such as luminaires the indirect light component of which radiates directly onto the sensor
- Daylight reflections, e.g. by mirrors
- Radio and/or Wi-Fi transmitters at a distance of approx. one metre

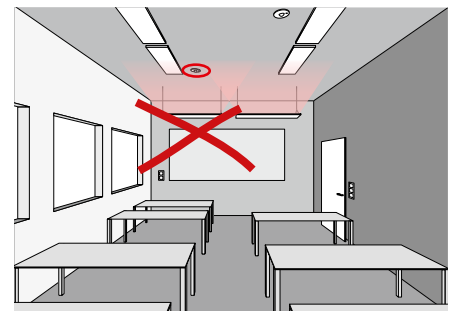

KNX INTERFACE

LiveLink and KNX – a perfect team

Especially in larger projects, building management systems based on KNX are used for networking and controlling various systems. The light management system is often handled as an integral component of the building management technology and must be accordingly integrated and controlled via KNX with high effort. In comparison, integrating the DALI-controlled LiveLink light management system offers several advantages.

Simple integration via ETS

With LiveLink, DALI-based lighting control can be seamlessly integrated into KNX building automation. In such cases the LiveLink KNX interface wirelessly connects the LiveLink system to the KNX system via a supplementary WLAN access point. Up to 6 LiveLink control units can be integrated for each KNX interface. All requisite characteristics and parameters of the LiveLink interface are already saved in the KNX ETS database for this purpose.

All luminaires at the same time

With LiveLink, it is no longer the case that each luminaire has to be individually addressed in KNX – now the whole room can be linked at the same time to the KNX system. The single luminaire groups and light scenes can then be conveniently assigned using the LiveLink app in the specific room.

Fewer additional hardware components

LiveLink pools all existing luminaires, sensors and push-buttons in the room and connects these together to the building technology via a single LiveLink KNX interface.

Plug & Play instead of programming

As standard, KNX offers no predefined module for constant light control, meaning complex programming would be required in such cases. HCL applications such as circadian light curves and colour sequences are also complex to create via KNX. With LiveLink on the other hand, these and many other applications can be quickly and simply implemented via plug & play..

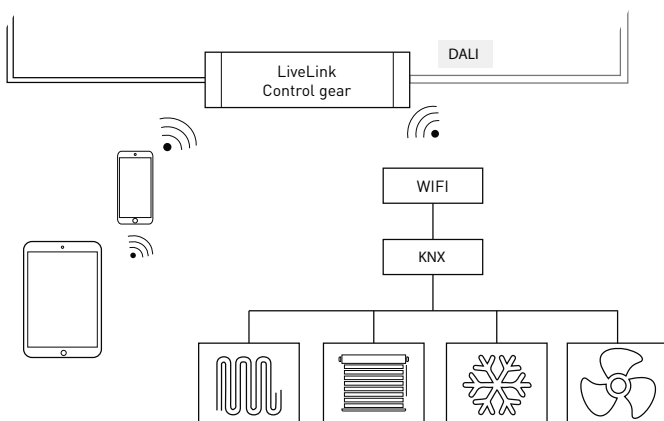

Technical data

Electrical safety	<ul style="list-style-type: none"> Protection rating (in accordance with EN 60529): IP20 Complies with EN 50491-3 Safety low voltage SELV DC 24 V
EMC requirements	<ul style="list-style-type: none"> Complies with EN 61000-6-2, EN 61000-6-3, EN 50491-5-1, EN 50491-5-2 and EN 50491-5-3 Complies with EMC directive (residential and functional buildings)
Environmental conditions	<ul style="list-style-type: none"> Ambient temperature in operation: -5 to +45 °C Storage temperature: -25 to +70 °C Relative humidity (non-condensing): 5% to 93%
Integrative LiveLink systems	max. 5
KNX data points	max. 1000
KNX interfaces	<ul style="list-style-type: none"> KNXnet/IP tunnelling (telegram level) KNX application layer (data point level)
KNX compatibility	<ul style="list-style-type: none"> KNXnet/IP specification Programming interface for ETS as of version 3c
Mechanical data	<ul style="list-style-type: none"> Housing: plastic Series installation, installation width 2 sub-units Weight: approx. 100 g
Operating elements	Teach-in buttons for KNX
Display elements	<ul style="list-style-type: none"> Teach-in LED (red) Display LED (green) for KNX Display LED (green) for LAN
Ethernet	<ul style="list-style-type: none"> 10BaseT (10Mbit/s) Internet protocols supported: ARP, ICMP, IGMP, UDP/IP, TCP/IP, DHCP and Auto IP
Power supply	<ul style="list-style-type: none"> Alternatively: Power-over-Ethernet External supply: 12-30V DC / 12-24V AC
Power consumption	<800 mW
Connections	<ul style="list-style-type: none"> KNX connection terminal LAN RJ-45 connection socket Screw terminals for supply voltage
TOC	6781200

WI-FI

The setup or control of the LiveLink system via tablet and/or smart phone app is only possible if a Wi-Fi connection with the LiveLink control device has been established.

In delivery condition, the LiveLink control device offers its own Wi-Fi for a direct connection (AdHoc connection). Each control device bears

a Wi-Fi name of its own, starting with "LIVELINK", which is printed onto the control device. The Wi-Fi name can be changed later, see chapter "Room setup: room name".

Optionally, the control device can be integrated into an existing Wi-Fi network and utilised from there.

CONNECT TO WI-FI

Selecting the Wi-Fi with an iOS device

All available Wi-Fi networks can be found in the Wi-Fi menu in the device settings screen.

Upon tapping the "LIVELINK..." Wi-Fi the connection will be established. The exact name (SSID) of the respective Wi-Fi is located on the control device. The password is "livelink".

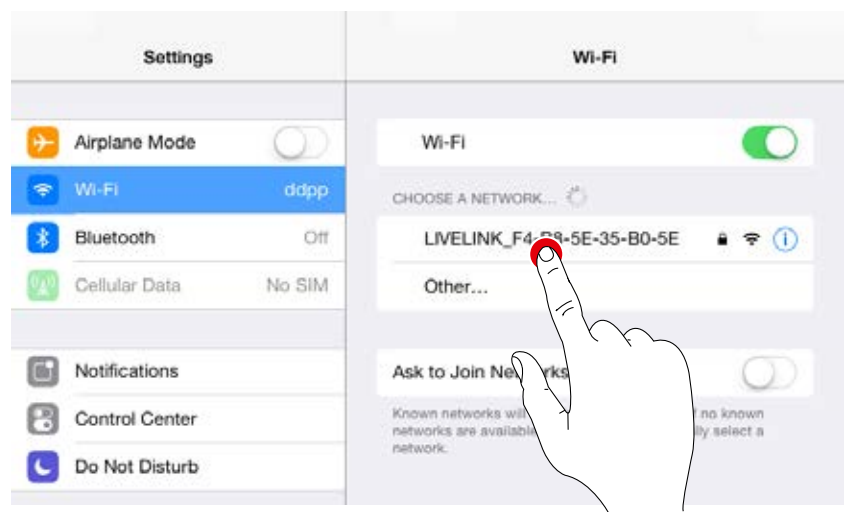

Selecting the Wi-Fi with an Android device

All available Wi-Fi networks can be found in the Wi-Fi menu in the device settings screen.

Upon tapping the "LIVELINK..." Wi-Fi the connection will be established. The password is "livelink".

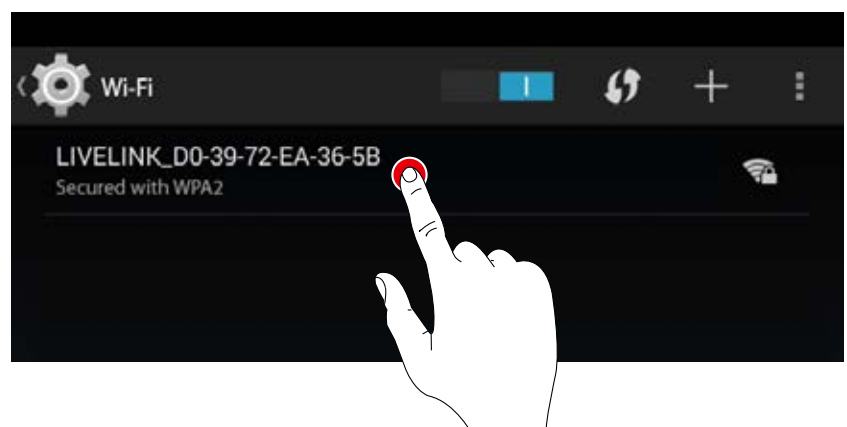
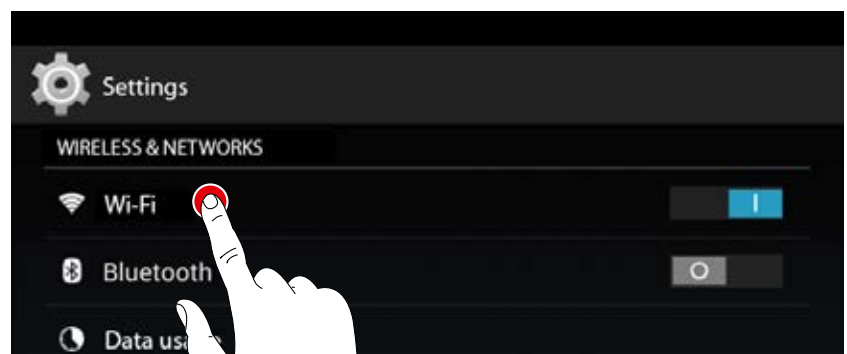

UTILISING AN EXISTING WI-FI NETWORK

Instead of a direct Wi-Fi connection between the iOS and/or Android device and the LiveLink control device, an existing network can also be utilised once the initial setup has been completed.

In order to do this, the control device needs to be connected to the existing local Wi-Fi network. The configuration is done via the administrator menu, see chapter "Room administration".

The iOS and/or Android app can then also be used in the local Wi-Fi network. All LiveLink rooms which are integrated into the local Wi-Fi network in the building can then be controlled via the app.

WI-FI SECURITY

Wi-Fi access to the LiveLink control device is protected by a three-tiered security concept.

1. In the first step, a password for the Wi-Fi must be entered (WPA2 encryption).
2. In the second step, a connection is established via https. This is an asymmetrical encryption. Data that is transmitted from the app to the LiveLink system and vice versa, can not be read in transit.
3. In the third step, a user authentication ensures that only those who are in possession of the administrator and/or user password can connect to the system and make changes.

This means that user access can be set up restrictively (via a separate app and separate password) they can operate the system, but cannot create new or change existing configurations.

ACCESS DATA

The LiveLink system provides different types of access for setup and operation. The access data should be changed upon initial setup and should be made available only to correspondingly authorised users.

	Description	Changing the data	Access data upon delivery
Wi-Fi name (SSID)	Name of the LiveLink Wi-Fi that is selected in case of a direct connection from the iOS and/or Android device.	See chapter "Room setup: room name"	LIVELINK_... <i>(see print on LiveLink control device)</i>
Wi-Fi password	Password for the direct Wi-Fi connection.	-	livelink
Administrator password	Password for using the administrator menu of the "Install" app. Each LiveLink room can be equipped with a separate administrator password.	Upon initial setup, the user is offered the option to change the administrator password. Subsequently, the password can be changed in the administrator menu under "Settings".	livelink
User password	Password for using the light control with the iOS and/or Android apps. Each LiveLink room can be equipped with a separate user password.	The user password is specified upon completion of the room setup. Subsequently, the password can be changed in the administrator menu under "Settings".	-

BEHAVIOUR OF LIGHT CONTROL

BEHAVIOUR IN DELIVERY CONDITION

If the control device and the luminaires were already installed, but the light control was not installed yet, the lighting can be switched and dimmed nevertheless (touch/dim function). Operation can be performed via any push-button connected to the control device:

- **Short push of button:** Turns all luminaires on or off
- **Long push of button:** Dimming all luminaires

The touch/dim function allows for a quick testing of the installation with all push-buttons and luminaires.

Caution: Initially, the touch/dim function is only available in delivery condition. During the configuration process, the function is not available, but can be re-assigned to select push-buttons.

BEHAVIOUR IN OPERATION

The behaviour of the light control depends on how the system is switched on:

- Fully automatic presence detection
- Starting a scene with semi-automatic presence detection
- Starting a scene with light control
- Manual switching on of all or selected luminaire groups

The decisive factor is, which controls (presence detection, light control) are contained in the default scene. In the public Use Cases, the respective most important scene is set as the default scene. In a lot of cases, this is an automatic scene with fully automatic presence detection and light control.

Additional information regarding this can be found in the chapter "What is a Use Case? / Public Use Cases".

On the following pages, the behaviour of the light control in the different situations is shown.

• CONSTANT LIGHT CONTROL
• PRESENCE DETECTION
(AUTOMATIC OPERATION)

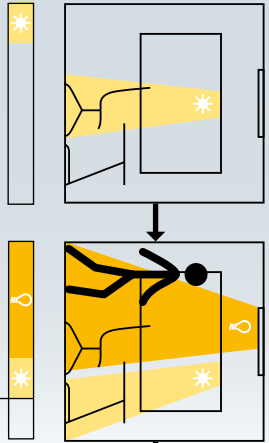

If the default scene contains presence detection with fully automatic operation, the lighting starts with the default scene upon entering the room.
If the scene additionally contains constant light control, the overall illumination (from daylight and artificial light) is continuously adjusted to the pre-set target value.

• CONSTANT LIGHT CONTROL
• PRESENCE DETECTION
(SEMI-AUTOMATIC OPERATION)

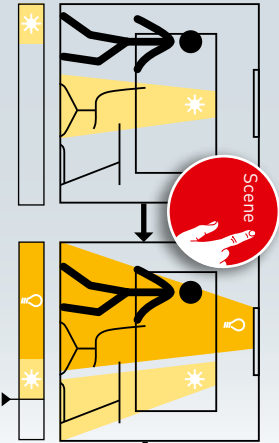

If the default scene contains presence detection with semi-automatic operation, the scene is started with a push-button or with a tablet or smart phone.
If the scene additionally contains constant light control, the overall illumination (from daylight and artificial light) is continuously adjusted to the pre-set target value.

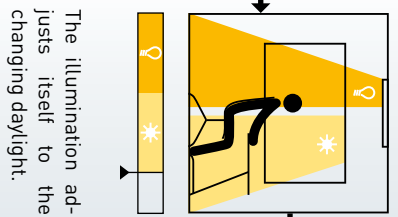

The illumination adjusts itself to the changing daylight.

In case of strong ingress of sunlight, the illumination initially dims to a minimum. If the overall illumination exceeds the target value by 25 % for more than 5 minutes, the lighting turns itself off.

If the amount of daylight decreases, the lighting switches itself on again and adjusts to the target value.

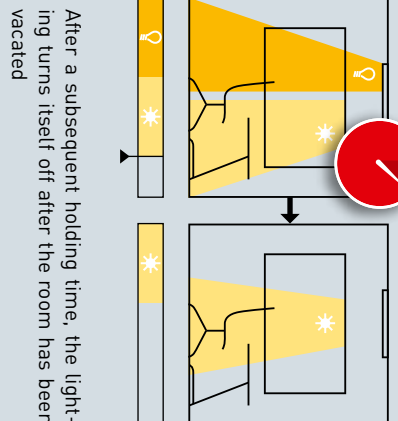

After a subsequent holding time, the lighting turns itself off after the room has been vacated

MANUAL CHANGES TO THE LIGHTING

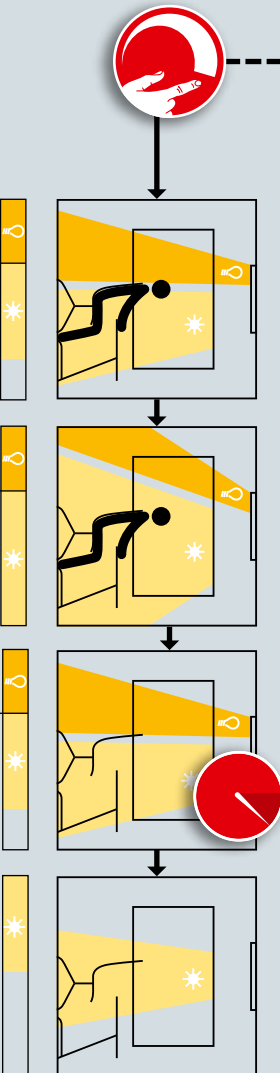

In the case of a manual intervention, the dimming and switching of luminaire groups, the constant light control is deactivated for these luminaire groups. During the stay in the room, the changed dimming levels of the lighting scene are retained.

The presence detection remains active even after a manual change of the lighting. After a subsequent holding time, it turns the lighting off after the room has been vacated.



CHANGE OF THE SCENE

If a change is made to a scene that contains other operating modes (constant light control and presence detection), the behaviour will of course, change as well (see other pages in this chapter).

ADVANCED SETTINGS

Through advanced settings in the default scene, a switching on again of the lighting upon dropping below the target value can be prevented.

PRESENCE DETECTION (AUTOMATIC OPERATION)

If the default scene contains presence detection with fully automatic operation, the lighting starts with the default scene upon entering the room.

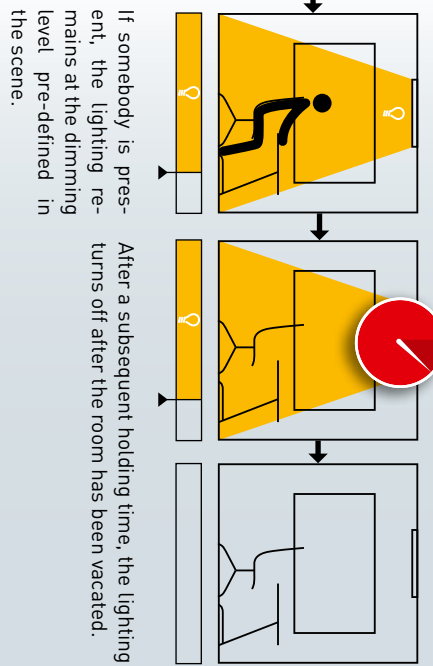
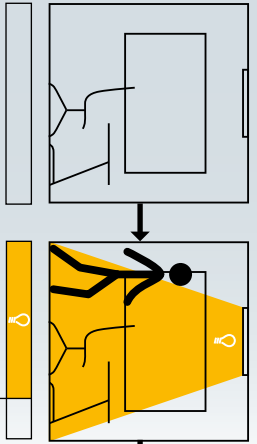

If somebody is present, the lighting remains at the dimming level pre-defined in the scene. After a subsequent holding time, the lighting turns off after the room has been vacated.

PRESENCE DETECTION (SEMI-AUTOMATIC OPERATION)

If the default scene contains presence detection with semi-automatic operation, the scene is started with a push-button or with a tablet or smart phone.

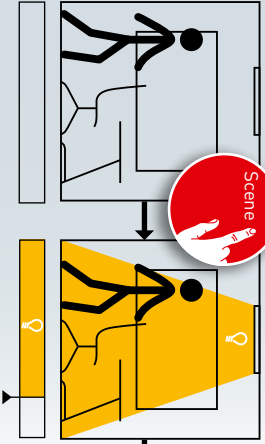

MANUAL CHANGES TO THE LIGHTING

Manual switching and after a manual change of the lighting. After a subsequent holding time, it turns the lighting off after the room has been vacated. The presence detection remains active even after a subsequent holding time, it turns the lighting off after the room has been vacated. They remain maintained during the stay in the room.

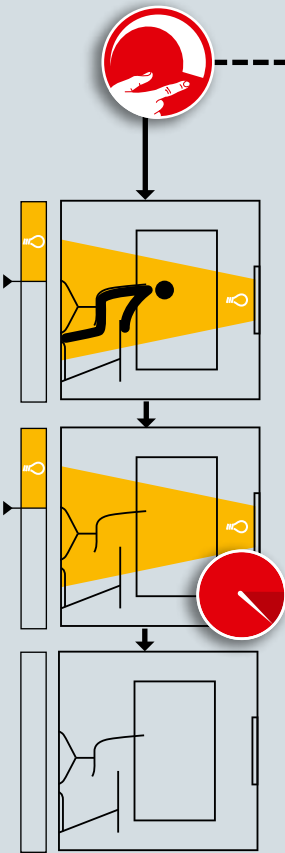

CHANGE OF THE SCENE

If a change is made to a scene that contains other controls (constant light control and presence detection), the behaviour will of course, change as well (see other pages in this chapter).



CONSTANT LIGHT CONTROL

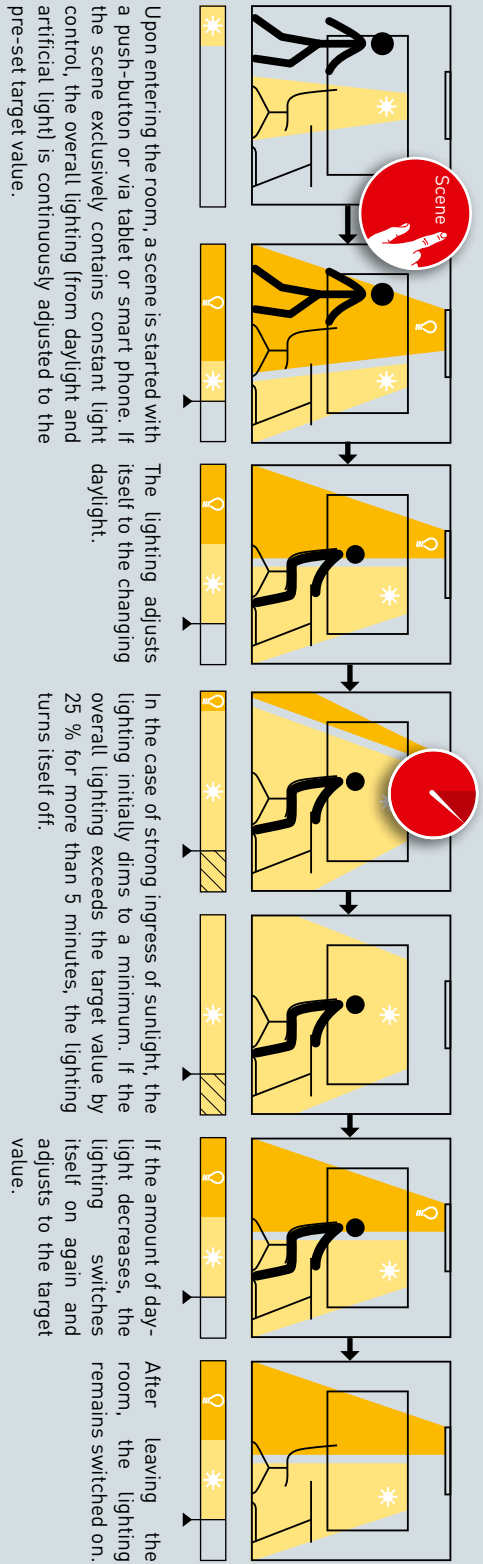

MANUAL CHANGES TO THE LIGHTING

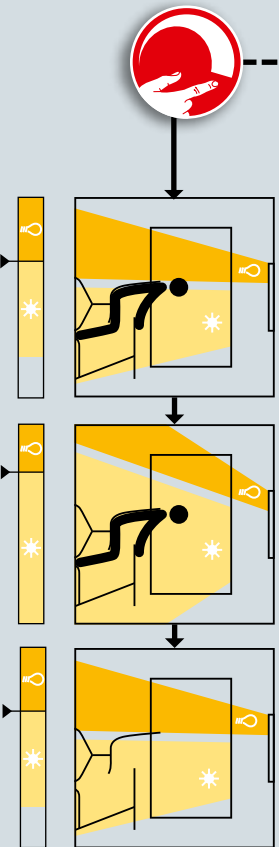

In the case of a manual intervention, the dimming and switching of luminaire groups, the constant light control is deactivated for these luminaire groups. During the stay in the room, the changed dimming levels of the lighting scene are retained.

CHANGE OF THE SCENE

If a change is made to a scene that contains other controls (constant light control and presence detection), the behaviour will, of course, change as well (see other pages in this chapter).

ADVANCED SETTINGS

Through advanced settings in the default scene, a switching on again of the lighting upon dropping below the target value can be prevented.



MANUAL CONTROL

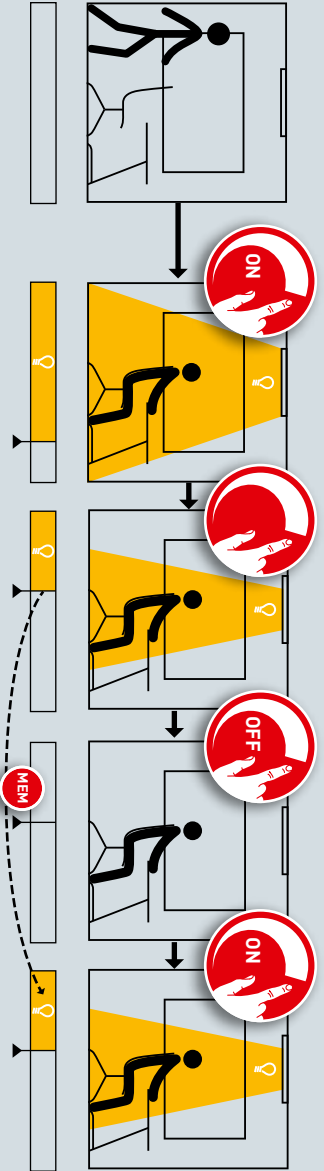

As an alternative to the automatic and manual starting of a scene, individual or all luminaire groups can be switched on with a push-button or via a tablet or smart phone, ...

... dimmed, ...

... and switched off.

Upon switching back on, the last dimming value will be recalled.



STARTING A SCENE

Scenes can also be started after manually switching on the lighting, of course (see the other pages of this chapter, depending on the control of the scene).

"LIVELINK INSTALL" APP

OVERVIEW

Apps are available both for devices running both iOS or Android operating systems, their functionality is the same, although there may be minor differences in how certain options appear on the screen.

The screenshots in this manual are taken from the the iOS app. Any differences in the operation of the Android app are pointed out where applicable.

The following screenshots show the basic elements of the app oper-

ation that are available for a comfortable operation throughout the whole app. Descriptions of these elements will not be repeated in the remainder of these instructions.

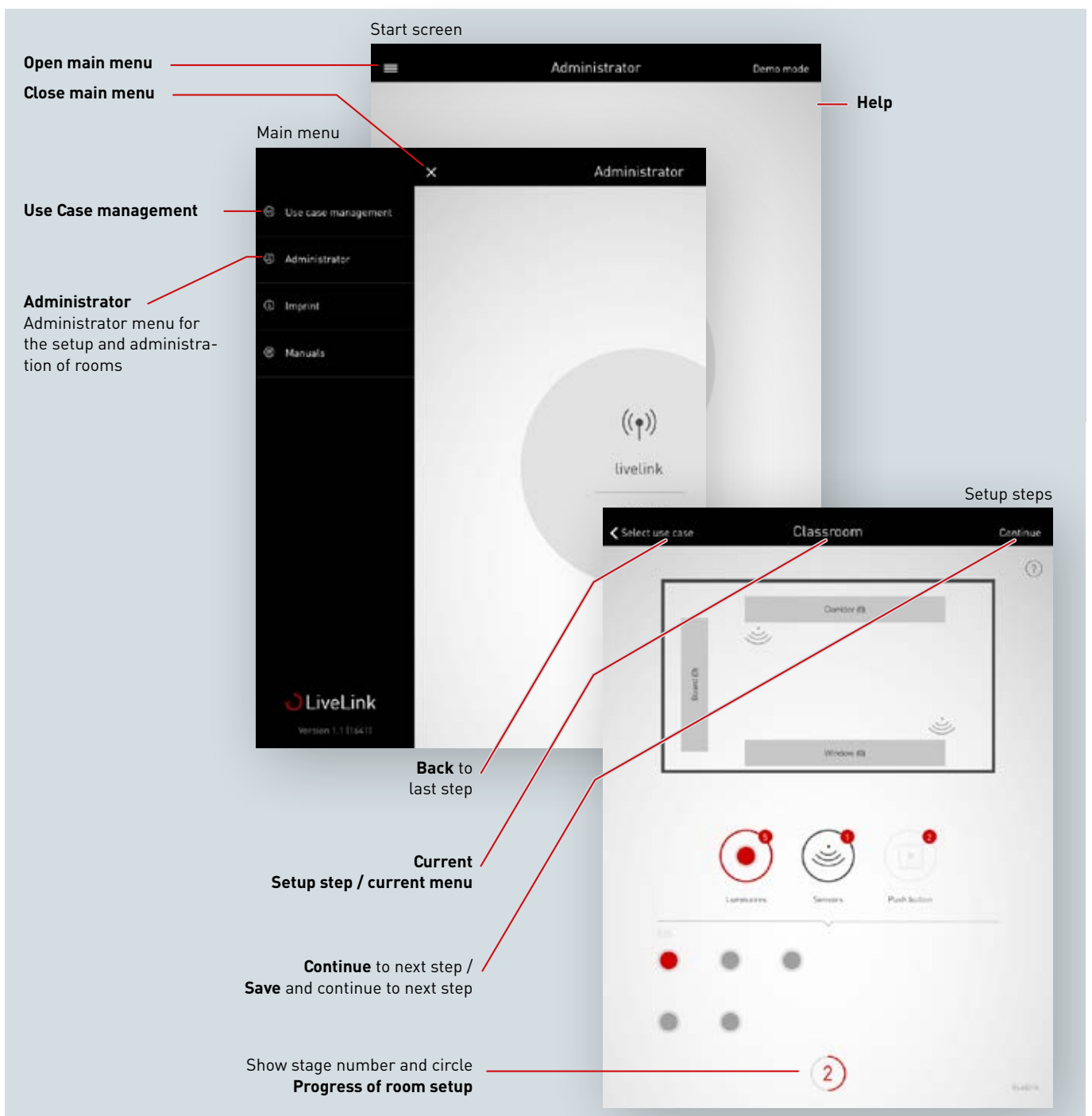

WHAT IS A USE CASE?

Each LiveLink room is set up based on a Use Case. A Use Case is a pre-configuration that simplifies the further setup of the room.

A Use Case defines:

- The number of luminaire groups (presentation of a schematic matching the room type)
- The assignment of sensors to luminaire groups
- Scenes included in the delivery (which of course, can be supplemented by scenes you create yourself)

In addition to the placement of luminaire groups, a Use Case also includes a pre-configuration of the sensors.

A Use Case constitutes the foundation of the room setup. If individualised Use Cases are needed, these can be created in cooperation with TRILUX lighting designers and loaded for utilisation as "Private Use Cases".

PUBLIC USE CASES

The public Use Cases are included in the scope of delivery and can be updated in the Use Case managements (see chapter "Use Case management").

The following Use Cases will be covered on the next pages.

Office	Industry	Education	Health & Care	General
<ul style="list-style-type: none"> • Small Office • Large Office • Conference Room 	<ul style="list-style-type: none"> • Manufacturing Hall • Manufacturing Hall, expanded 	<ul style="list-style-type: none"> • Classroom • Sports Hall 	<ul style="list-style-type: none"> • Patients' room 	<ul style="list-style-type: none"> • Corridor • Universal (See chapter "Universal Use Case")

After completion of the steps for commissioning, the scenes pre-set in the Use Cases can be adjusted or additional ones added. You can, for example, change the switch-off delays, switch from fully automatic to semi-automatic operation, or change the dimming level.

The daylight-dependent control requires an initial calibration with the help of a light meter (see chapter "Scene management").

Use Case "Small Office"

In the Use Case "Small Office", the luminaire groups "Work", "Meeting" and "Additional" are applied. In addition, there is one sensor that is responsible for daylight-dependent light control as well as presence detection.

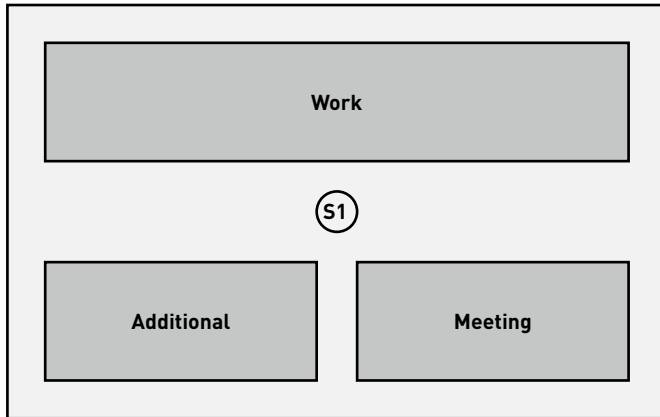

Preset luminaire groups	
Luminaire Group	Function
Work	<ul style="list-style-type: none"> • Presence detection • Daylight-dependent control
Meeting	<ul style="list-style-type: none"> • Presence detection
Additional e. g. for accent lighting	<ul style="list-style-type: none"> • Presence detection

Preset scenes	
Scene	Function
Automatic	<ul style="list-style-type: none"> • 5 minutes switch-off delay • Fully automatic operation for the group "Work" • Daylight-dependent control active
Meeting	<ul style="list-style-type: none"> • Constant dimming levels for all groups: <ul style="list-style-type: none"> • Work 50 % • Meeting 100 % • Additional 20 % • 10 minutes switch-off delay
Service	<ul style="list-style-type: none"> • Constant dimming level for all groups at 100 % • 10 minutes switch-off delay
Night lighting	<ul style="list-style-type: none"> • Constant dimming level for all groups at 20 % • No automatic switch-off
Off	<ul style="list-style-type: none"> • All groups off

Use Case "Large Office"

In the Use Case "Large Office", the luminaire groups "Traffic Route", "Work 2", "Work 3", "Work 4" and "Additional" are applied. In addition, there are four sensors which are responsible for daylight-dependent light control as well as presence detection. This is done separately for each group.

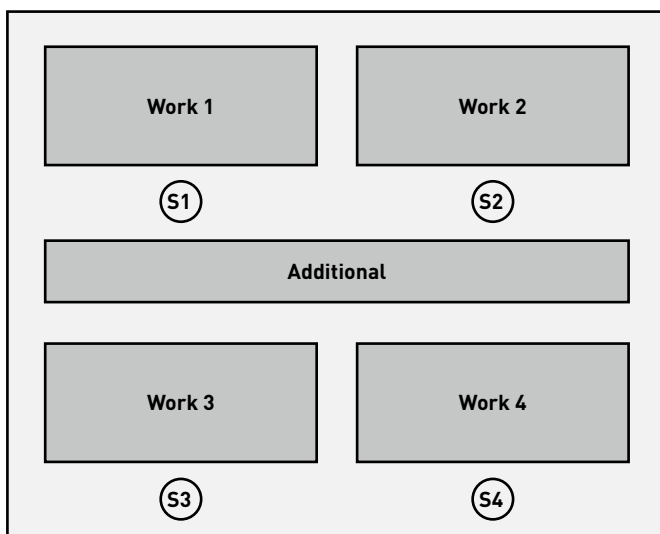

Preset luminaire groups	
Luminaire Group	Function
Work 1-4	<ul style="list-style-type: none"> • Presence detection • Daylight-dependent control
Additional e. g. for accent lighting	<ul style="list-style-type: none"> • Presence detection

Preset scenes	
Scene	Function
Automatic	<ul style="list-style-type: none"> • 5 minutes switch-off delay, fully automatic operation • Daylight control active via sensors S1-4, each separately
Service	<ul style="list-style-type: none"> • Constant dimming level for all groups at 100 % • 10 minutes switch-off delay
Night lighting	<ul style="list-style-type: none"> • Constant dimming level for all groups at 20 % • No automatic switch-off
Off	<ul style="list-style-type: none"> • All groups off

Use Case "Conference Room"

In the Use Case "Conference Room", the luminaire groups "Meeting", "Presentation" and "Additional" are applied. In addition, there is also one sensor which is responsible for daylight-dependent light control as well as presence detection.

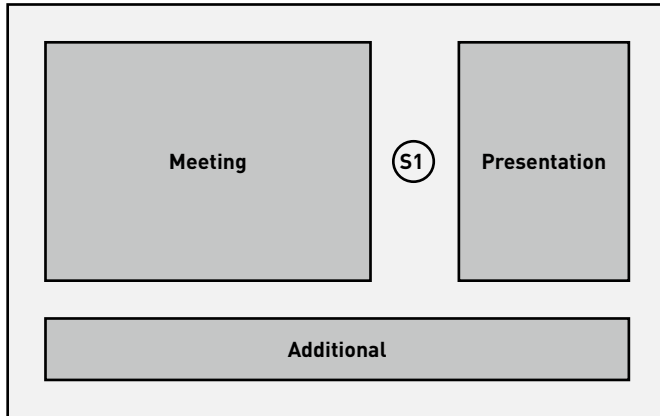

Preset luminaire groups	
Luminaire Group	Function
Meeting	Presence detection Daylight-dependent control
Presentation	Presence detection Daylight-dependent control
Additional e. g. for accent lighting	Presence detection

Preset scenes	
Scene	Function
Automatic	<ul style="list-style-type: none"> • 10 minutes switch-off delay for all groups, fully automatic operation • Daylight-dependent control active
Projection	<ul style="list-style-type: none"> • Constant dimming levels for the following groups: <ul style="list-style-type: none"> • Meeting 20% • Additional 20 % • Presentation 0 % • 10 minutes switch-off delay
Lecture	<ul style="list-style-type: none"> • Constant dimming levels for the following groups: <ul style="list-style-type: none"> • Meeting 50% • Additional 20 % • Presentation 100% • 10 minutes switch-off delay
Service	<ul style="list-style-type: none"> • Constant dimming level for all groups at 100 % • 10 minutes switch-off delay
Night lighting	<ul style="list-style-type: none"> • Constant dimming level for all groups at 20 % • No automatic switch-off
Off	<ul style="list-style-type: none"> • All groups off

Use Case "Manufacturing Hall"

In the Use Case "Manufacturing Hall, simple", the luminaire groups "Traffic Route", "Work 1", "Work 2" and "Work 3" are applied. In addition, there are three sensors which are responsible for daylight--dependent light control (SA1 - 3) and three sensors that are responsible for presence detection (SV1 - 3).

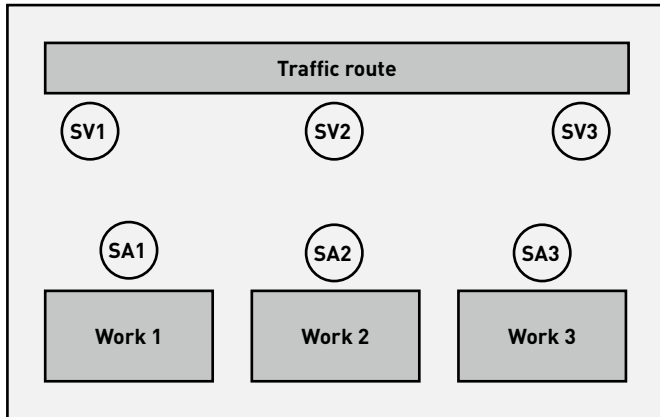

Preset luminaire groups	
Luminaire Group	Function
Traffic route	<ul style="list-style-type: none"> • Presence detection via the sensors SV1-3
Work 1-3	<ul style="list-style-type: none"> • Manual switching • Daylight-dependent control via sensor SA1-3

Preset scenes	
Scene	Function
Automatic	<ul style="list-style-type: none"> • Daylight control active for groups "Work 1-3" • Presence detection for group "Traffic Route", Fully automatic operation with 10 minutes switch-off delay
Service	<ul style="list-style-type: none"> • Constant dimming level for all groups at 100 % • 20 minutes switch-off delay
Night lighting	<ul style="list-style-type: none"> • Constant dimming level for all groups at 20 % • No automatic switch-off
Off	<ul style="list-style-type: none"> • All groups off

Use Case "Manufacturing Hall, expanded"

In the Use Case "Manufacturing Hall, expanded", the luminaire groups "Traffic Route 1", "Traffic Route 2", "Work 1", "Work 2", "Work 3", "Work 4", "Work 5" and "Work 6" are applied. In addition, there are six sensors which are responsible for daylight-dependent light control (SA1 - 6) and a further six sensors which are responsible for presence detection (SV1 - 6).

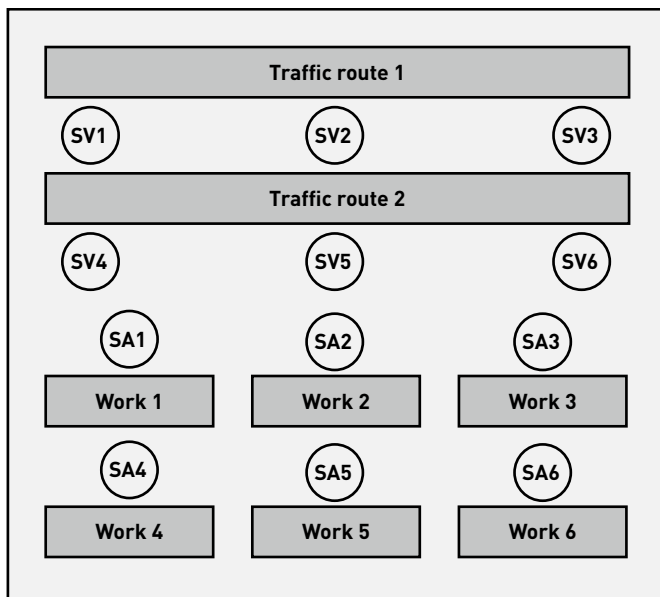

Preset luminaire groups	
Luminaire Group	Function
Traffic route 1-2	<ul style="list-style-type: none"> • Presence detection
Work 1-6	<ul style="list-style-type: none"> • Manual switching • Daylight-dependent control

Preset scenes	
Scene	Function
Automatic	<ul style="list-style-type: none"> • Daylight-dependent control active via sensors SA1-6 (per group) • Presence detection with 10 minutes switch-off delay (sensor SV1-6), fully automatic operation
Service	<ul style="list-style-type: none"> • Constant dimming level for all groups at 100 % • 20 minutes switch-off delay
Night lighting	<ul style="list-style-type: none"> • Constant dimming level for all groups at 20 % • No automatic switch-off
Off	<ul style="list-style-type: none"> • All groups off

Use Case "Classroom"

In the Use Case "Classroom", the luminaire groups "Board", "Window", and "Corridor (+ Centre)" are applied. In addition, there are two sensors which are responsible for daylight-dependent light control as well as the presence detection per group.

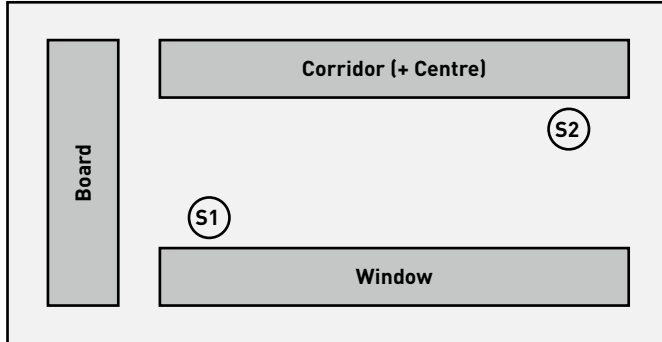

Preset luminaire groups	
Luminaire Group	Function
Board	<ul style="list-style-type: none"> • Presence detection
Window	<ul style="list-style-type: none"> • Presence detection • Daylight-dependent control
Corridor (+ Centre)	<ul style="list-style-type: none"> • Presence detection • Daylight-dependent control

Preset scenes	
Scene	Function
Automatic	<ul style="list-style-type: none"> • 10 minutes switch-off delay, semi-automatic operation for all groups • Individualised daylight-dependent control for the groups "Window" (S1) and "Corridor" (S2)
Projection	<ul style="list-style-type: none"> • Constant dimming levels for the following groups: <ul style="list-style-type: none"> • Board 0 % • Window 20 % • Corridor 20 % • 5 minutes switch-off delay
Service	<ul style="list-style-type: none"> • Constant dimming level for all groups at 100 % • 10 minutes switch-off delay
Night lighting	<ul style="list-style-type: none"> • Constant dimming level for all groups at 20 % • No automatic switch-off
Off	<ul style="list-style-type: none"> • All groups off

Use Case "Sports Hall"

In the Use Case "Individual Sports Hall", the luminaire group "Hall" is applied. In addition, there is a sensor (S1) which is responsible for the daylight-dependent light control as well as the presence detection, and a sensor (S2) which is responsible for presence detection.

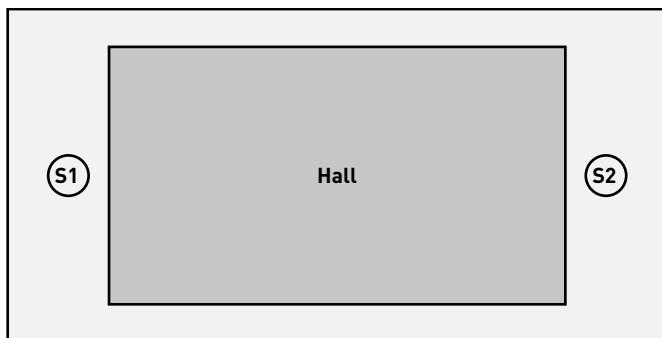

Preset luminaire groups	
Luminaire Group	Function
Hall	<ul style="list-style-type: none"> • Presence detection, • Daylight-dependent control

Preset scenes	
Scene	Function
Automatic standard	<ul style="list-style-type: none"> • 15 minutes switch-off delay, fully automatic operation • Daylight-dependent control active with 85 % of the system's output
Automatic bright	<ul style="list-style-type: none"> • 15 minutes switch-off delay, fully automatic operation • Daylight-dependent control active with 100% of the system's output
Service	<ul style="list-style-type: none"> • Constant dimming level for all groups at 100 % • 10 minutes switch-off delay, semi-automatic operation
Night lighting	<ul style="list-style-type: none"> • Constant dimming level for all groups at 20% • No automatic switch-off
Off	<ul style="list-style-type: none"> • All groups off

Use Case "Patients' Room"

In the Use Case "Patients' Room", the luminaire groups "Bathroom", "Room", "Table", "Bed 1", "Bed 2" and "Bed 3" are applied. In addition, there are two sensors, one of which is responsible for daylight-dependent light control and presence detection (S1) and the other is responsible for presence detection in the bathroom (S2).

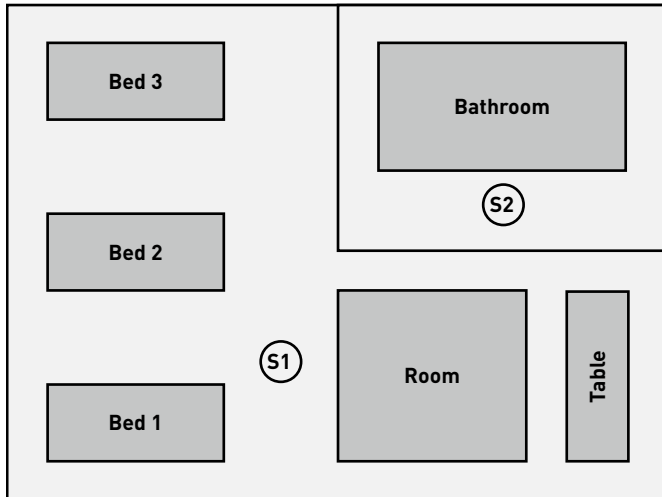

Preset luminaire groups	
Luminaire Group	Function
Bed 1-3	<ul style="list-style-type: none"> • Presence detection • Daylight-dependent control
Room	<ul style="list-style-type: none"> • Presence detection • Daylight-dependent control
Table	<ul style="list-style-type: none"> • Presence detection
Bathroom	<ul style="list-style-type: none"> • Presence detection

Preset scenes	
Scene	Function
Automatic	<ul style="list-style-type: none"> • Presence detection for beds, room and table in semi-automatic operation • Presence detection for the bathroom in fully automatic operation • Daylight-dependent control active
Examination	<ul style="list-style-type: none"> • Constant dimming level for all groups at 100% • No automatic switch-off
Service	<ul style="list-style-type: none"> • Constant dimming level for all groups at 100 % • 10 minutes switch-off delay
Off	<ul style="list-style-type: none"> • All groups off

Use Case "Corridor"

In the Use Case "Corridor", the luminaire group "Corridor" is applied. In addition, there are three sensors which are responsible for daylight-dependent light control as well as presence detection. Sensors 1-3 control the presence detection, sensor 1 the daylight-dependent control.

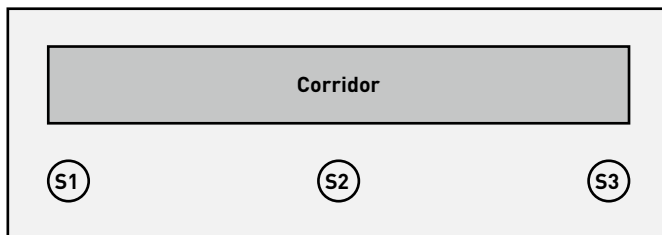

Preset luminaire groups	
Luminaire Group	Function
Corridor	<ul style="list-style-type: none"> • Presence detection • Daylight-dependent control

Preset scenes	
Scene	Function
Automatic	<ul style="list-style-type: none"> • 5 minutes switch-off delay, fully automatic operation • Daylight-dependent control active (via sensor 1)
Service	<ul style="list-style-type: none"> • Constant dimming level for all groups at 100 % • 10 minutes switch-off delay
Night lighting	<ul style="list-style-type: none"> • Constant dimming level for all groups at 20 % • No automatic switch-off
Off	<ul style="list-style-type: none"> • All groups off

PRIVATE USE CASES

Project-related, Use Cases are always created in cooperation with TRILUX lighting designers. The finished Use Cases are then made available in the customer account of the myTRILUX portal [see chapter "Use Case Management"].

UNIVERSAL USE CASE

In addition to the application of specific Use Cases (public & private), the public Use Case "Universal" is also available. In the Use Case "Universal", nine freely assignable luminaire groups "G1-G9" are applied. In addition, there are nine freely assignable sensor spots which are responsible for daylight-dependent light control as well as presence detection.

Preset scenes	
Scene	Function
ON	• All groups at 100 %
OFF	• All groups off

Additional scenes must be created manually.

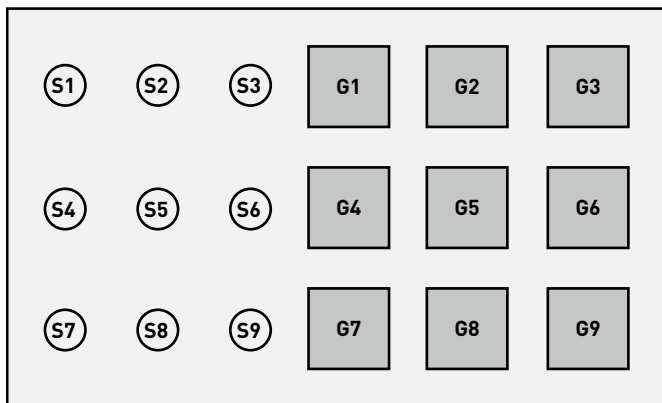

USE CASE MANAGEMENT

In this screen, Use Cases can be managed.

Public Use Cases can be updated and deleted. Private Use Cases can be downloaded from the myTRILUX Portal and managed.

Updating

Updating the public Use Cases from the TRILUX portal.

Public Use Cases

All available Use Cases are listed. After a long tap, there is the option to delete selected Use Cases.

Private Use Cases

Access to the TRILUX portal, from which private Use Cases can be loaded at this point.



Use Case name

Version number

MANAGING PUBLIC USE CASES

Updating Use Cases

The menu "Manage Use Cases" starts with a listing of all public Use Cases that are available in the app for the configuration of rooms.

The Use Cases listed here can be updated by tapping the refresh button.

Caution: Updating requires an Internet connection as the data is retrieved from a TRILUX server via the Internet. Where applicable, the Wi-Fi must be switched on, or a mobile data connection must be utilised.



Deleting Use Cases

After an update, Use Cases may be listed multiple times with different version numbers. Superfluous Use Cases can be deleted: After a long tap on the Use Case button, the Use case can be deleted.

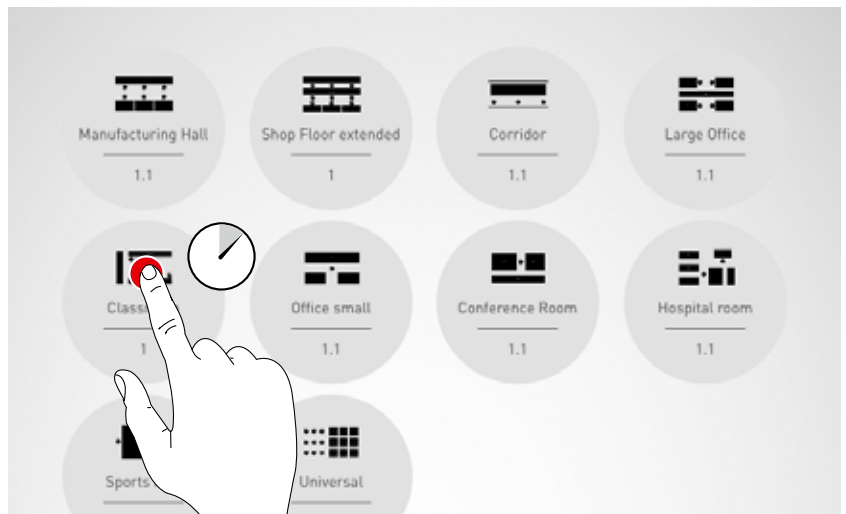

MANAGING PRIVATE USE CASES

Selecting private Use Cases

With a tap on "Private Use Cases", the screen switches to "Manage private Use Cases".



Managing private Use Cases

The input screen allows access to the customer's account on the myTRILUX portal. Here, the customised Use Cases previously created are available.

Caution: Access to the myTRILUX portal requires an Internet connection. Where applicable, the Wi-Fi must be switched on, or a mobile data connection must be utilised.



ROOM MANAGEMENT

The Administrator menu includes the most important functions of the setup app: the setup and/or management of rooms as well as various settings. The menu is protected with a separate administrator password.

Room name
All settings in this administrator menu refer to this room.

Light control
Access to the light control; functionality as user app.

Create room
Guides the user through the individual steps of the initial setup of a new room. If this room was previously created, its existing configuration can be deleted at this point and a new room setup can be started.

Room management
After the initial setup, selected setup steps can be changed here:

- Use Case
- Assignment
- Manage push-buttons
- Rename room
- Manage scenes
- Setting up basic lighting
- Set up KNX

Settings
Accesses various additional settings.

Wi-Fi / Hotspot
Connecting the control device with an existing local Wi-Fi network.

ROOM SETUP

Upon the initial setup, a connection to the system is established and prepared for the further configuration.

Initial connection to the Wi-Fi

The tablet is connected directly to the Wi-Fi network which is made available by the LiveLink control device.

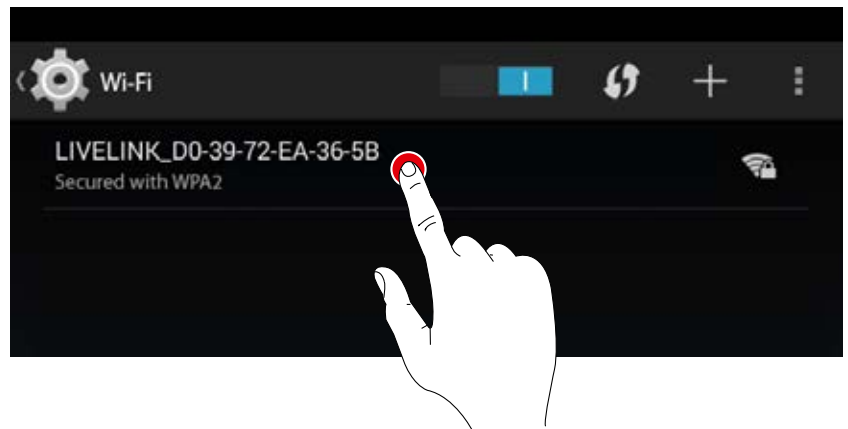
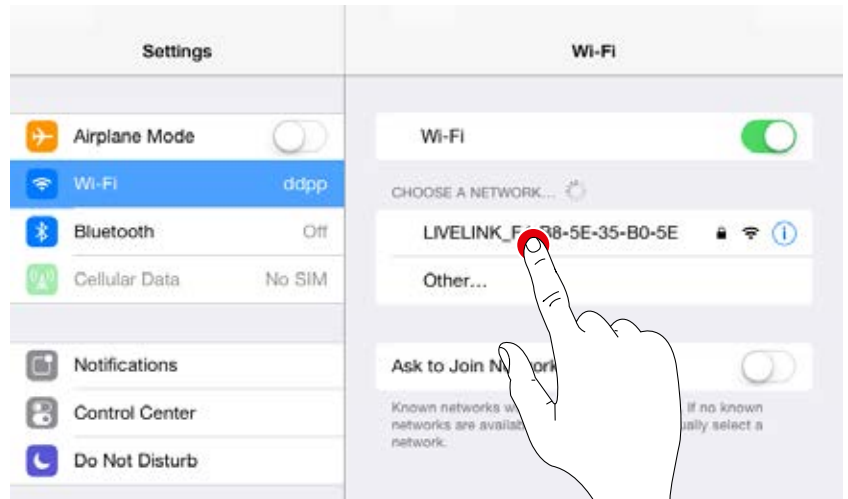

Start the app

To configure LiveLink, the "LiveLink Install" app is utilised which is available for iOS tablets at the Apple App Store and for Android tablets at the Google Play Store.



Select room

The app starts in the administrator menu and searches for existing LiveLink rooms. Here, the not-yet set up room can be selected. Initially, the room designation is a factory setting which can later be changed in the "Room name" menu. In delivery condition, the administrator password is: **livelink**

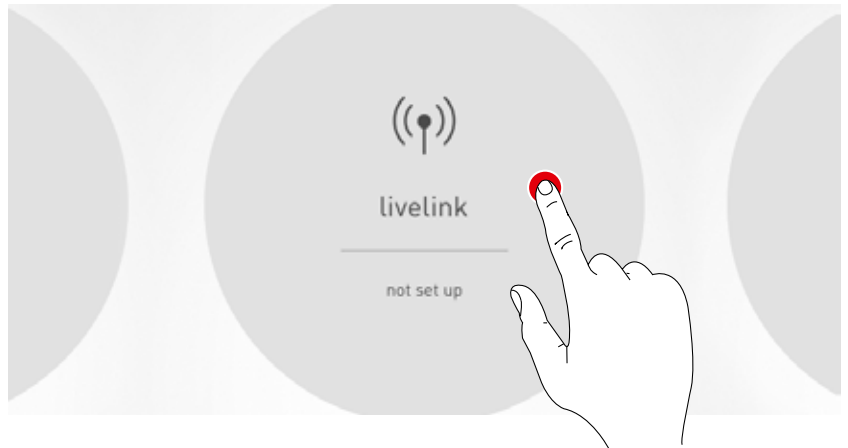

Change administrator password

On the next screen, a new administrator password can be set.

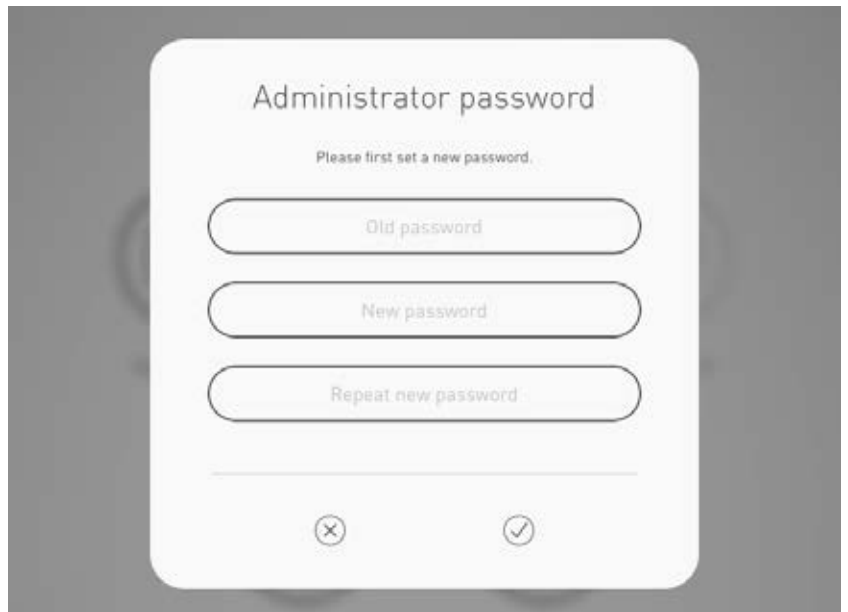

Start room configuration

A tap on "Create room" starts the creation of a room and leads to the first step "Select Use Case".

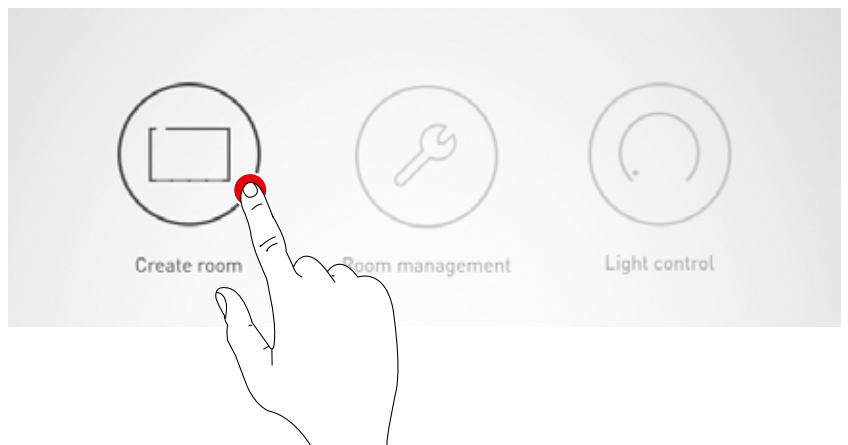

ROOM SETUP: USE CASE

In this screen, a matching Use Case is selected and assigned to the room.

Represented in a simplified room schematic - show the placement of luminaire groups and sensors as well as pre-configured light scenes.

For typical room situations, multiple "public Use Cases" are available. For special applications, individualised "private Use Cases" can be called up.

This screen also provides an overview of the connected luminaires, sensors and push-buttons as well as the option to identify these devices.

1. Identifying luminaires and sensors
2. Select and confirm Use Case

Name and schematic of the selected Use Case. The Use Case can be selected via swiping. A tap on this schematic confirms the selection and leads to the next step.

The dots serve for **navigating through the Use Cases**. One dot corresponds to one Use Case. The currently selected Use Case is displayed in red.

The number indicates the **number of luminaires connected**. After tapping this icon, the luminaires blink for identification. While this is happening, the icon is shown in red. The identification is ended by tapping again.

Choose between **public and private Use Cases**. Public Use Cases contain a pre-configuration for typical building situations. Private Use Cases can be created in cooperation with TRILUX lighting designers and can subsequently be called up from the myTRILUX portal.

After tapping the refresh button, a choice of "Start new search run" and "Search for new devices" is available. A status display indicates an active search. **Caution: A "search run" impedes the functionality of the system; see explanation on the following pages.**

The number indicates the **number of sensors connected**. After tapping this icon, the status lights of the sensors light up for identification. While this is happening, the icon is shown in red. The identification is ended by tapping again.

The number indicates the **number of push-button couplers connected plus the allowed push-button on the control device**. Push-buttons connected to a coupler are not included in the count at this point.

Listing connected devices

Numbers on the icons of the device groups "Luminaires", "Sensors" and "Push-buttons" indicate the respective number of devices connected. A push-button coupler is counted only once in this, even though multiple push-buttons may be connected there.

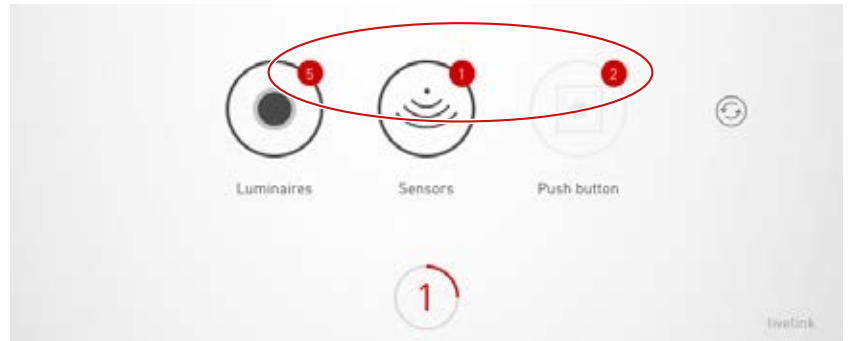

Identifying luminaires/sensors

When selecting the group "Luminaires" or "Sensors", the identification is started: The respective icon is shown in red; the registered luminaires and/or the status lights of the sensors start to blink.

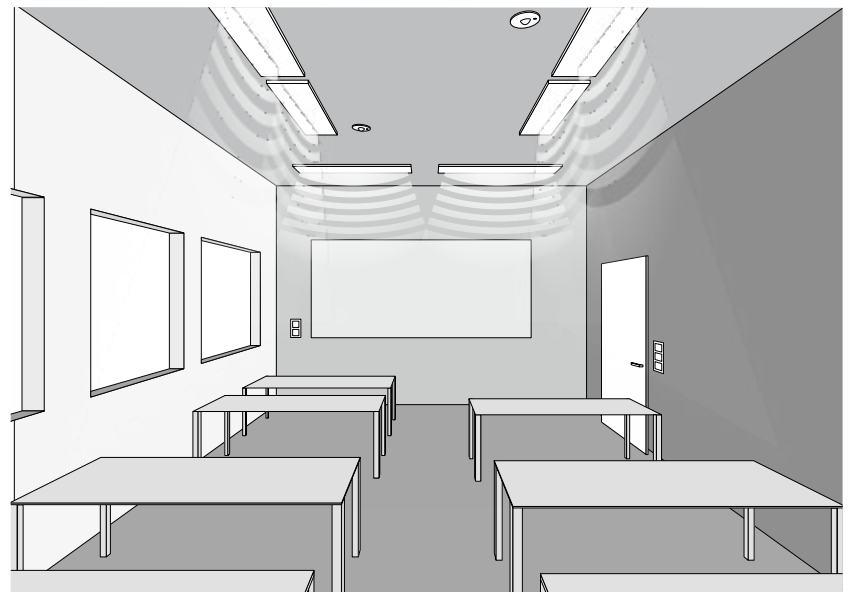

New search run / search for devices

If the search run upon commissioning did not find all devices or if work is being performed on the installation in parallel, the search run and/or a search for devices can be started again.

With a tap on the refresh button, a choice between a new search run and a search for devices is available.

- **"Start new search run"** search again for all connected DALI members and addresses all devices. This is necessary if a previous search run was incomplete or incorrect, e.g. if - despite correct installation - not all devices were found.

Caution: A renewed search run impedes the functionality of the system. Due to the re-addressing of the devices, the assignment needs to be performed once again.

- **"Search for new devices"** locates devices not yet addressed (e.g. for subsequently installed devices). This search run is significantly faster and does not lead to a change of the existing configuration.

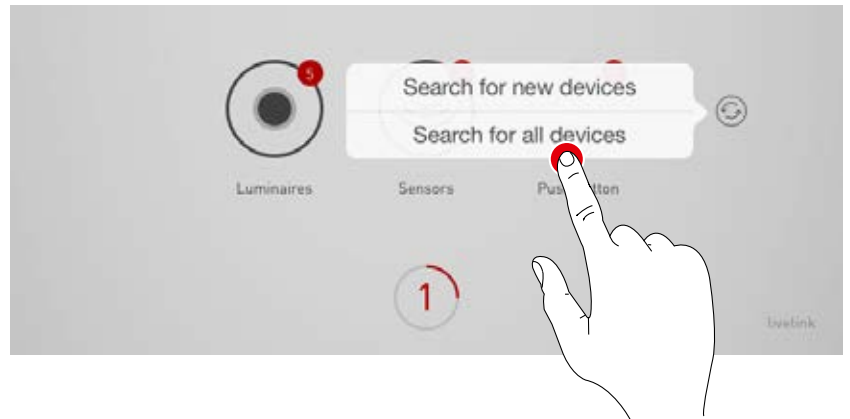

Public / private Use Cases

Initially, the corresponding Use Case collection is selected by tapping on "Public Use Cases" or "Private Use Cases".

Additional information regarding this can be found in the chapter "Use Case management".



Selecting a Use Case

A matching Use Case is selected by swiping. A rough schematic and the naming help in the correct selection, whereby the schematic does not have to fit the room situation in all details.

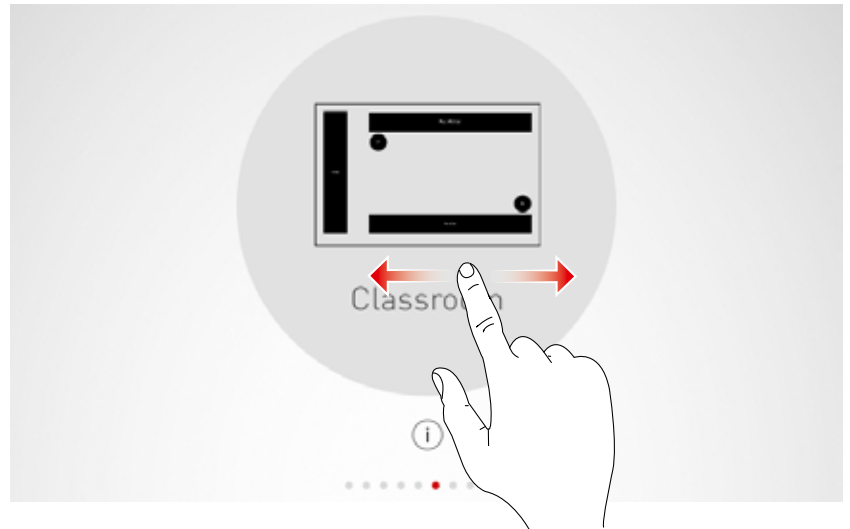

Confirming the selection

The selection is confirmed by tapping on the Use Case and this configuration step is completed.

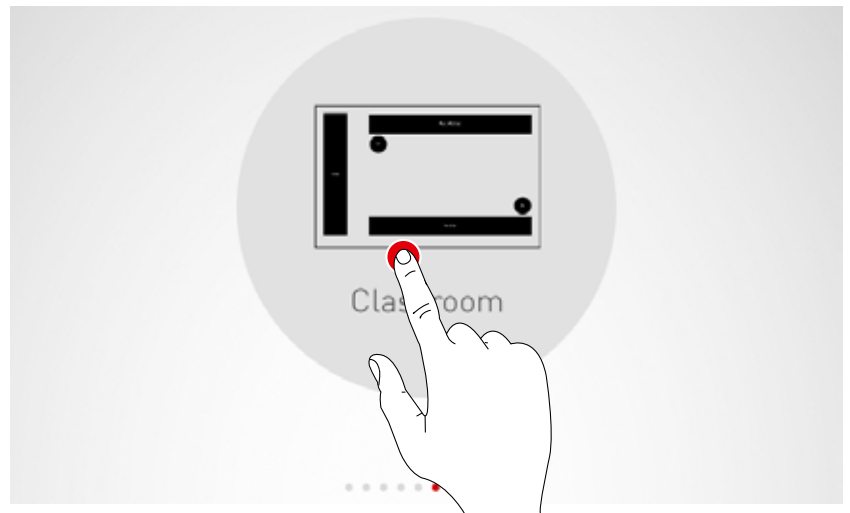

ROOM SETUP: ASSIGNMENT

1. Luminaire Group assignment

2. Sensor assignment

In this screen, the luminaires and sensors are assigned.

The individual luminaires and sensors can be identified and assigned to the luminaire groups and/or sensor locations.

A simplified schematic serves for orientation in the room and aids a comfortable assignment of the devices this way. The number and positions of the luminaire groups and sensors originate from the Use Case. The schematic cannot be modified but can be utilised in a custom fashion, as such, not all luminaire groups and sensor locations have to be utilised.

Pre-defined luminaire groups are included in each room. The available luminaires can be assigned via drag and drop. The number to the right of the group name indicates how many luminaires are in the group.

The **room schematic** shows all luminaire groups and sensor locations.

Pre-defined sensor The available sensors can be assigned via drag and drop. Subsequent to a long tap, additional functions can be reached.

Switching between the assignment of luminaires and sensors. The respective active devices are shown in red. Additionally, the number of push-button couplers (plus the push-button on the control device) available is displayed for indication purposes. The push-button assignment is performed in a later step.

Overview of the luminaires and/or sensors already assigned in comparison to those available.

Symbolic depiction of the available luminaires and/or sensors. As soon as a device is selected, it is displayed in red and can then be assigned.

Selecting luminaires

Each dot in the lower area of this screen represents a luminaire. The luminaire can be selected by tapping a dot. The dot is shown red and the corresponding luminaire blinks for identification.

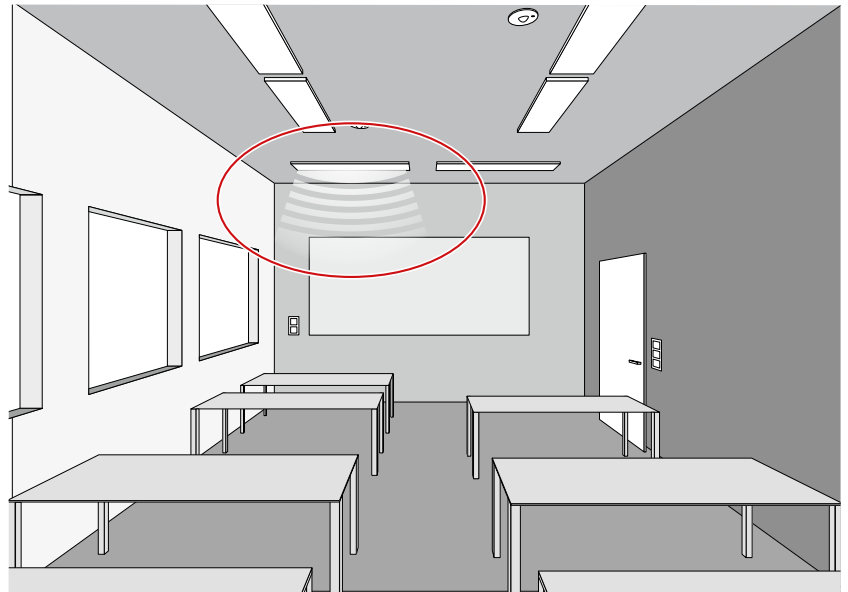
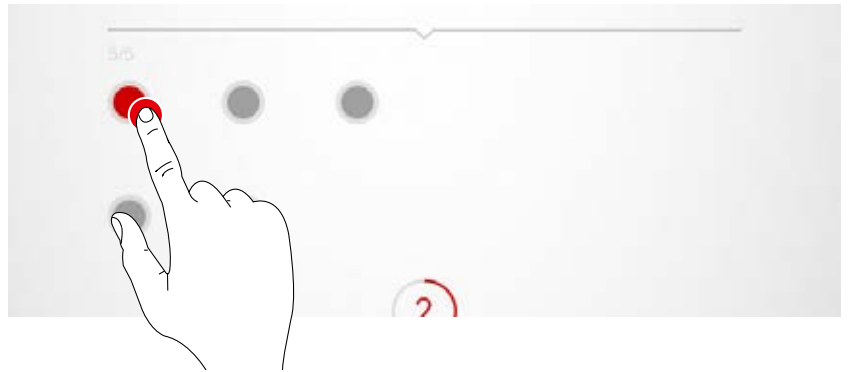

Multiple selection

Multiple luminaires can be selected one after another in order to assign them collectively in the next step.

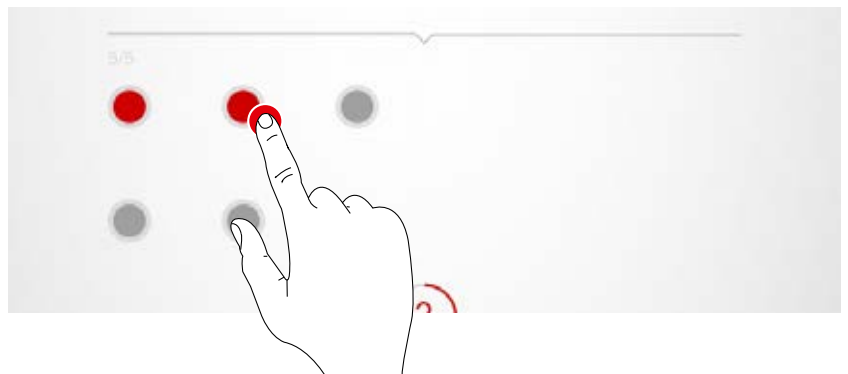

Assigning luminaires

The selected luminaires can now be pushed to a luminaire group at the top of the screen.. If multiple luminaires were selected, any one luminaire can be pushed in order to assign the whole selection. The dots that symbolise the luminaires are no longer shown after the assignment.

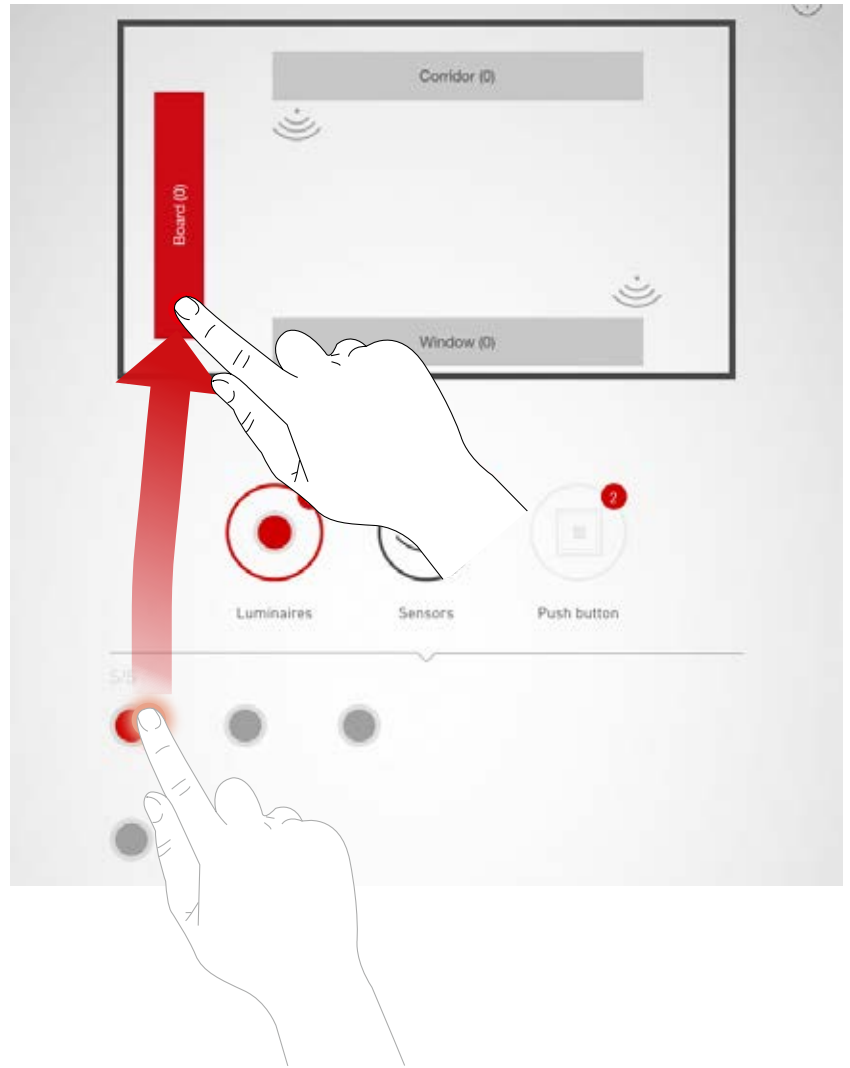

Navigation in case of more than 12 luminaires

If more luminaires are available, the luminaire selection is navigated by swiping through the pages.

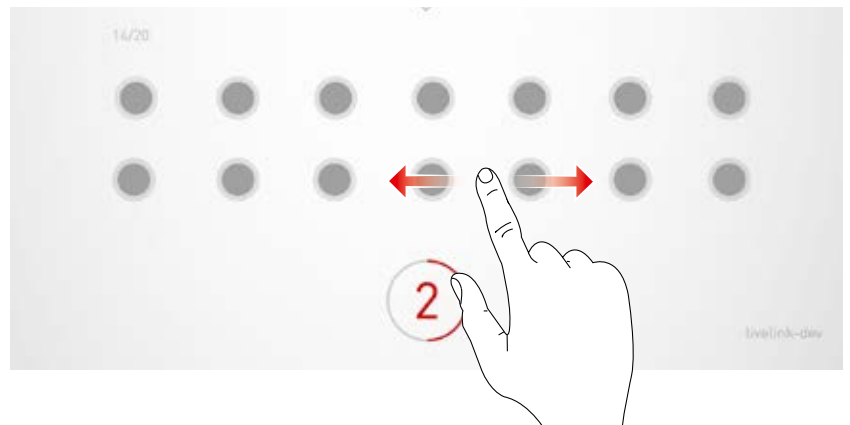

Checking the assignment

The number of luminaires already assigned can be read on the symbols of the luminaire groups. In addition to this, in the bottom area of the screen the overall number of available luminaires overall is displayed and how many have not yet been assigned.

A group is selected by tapping on it. All corresponding luminaires blink.

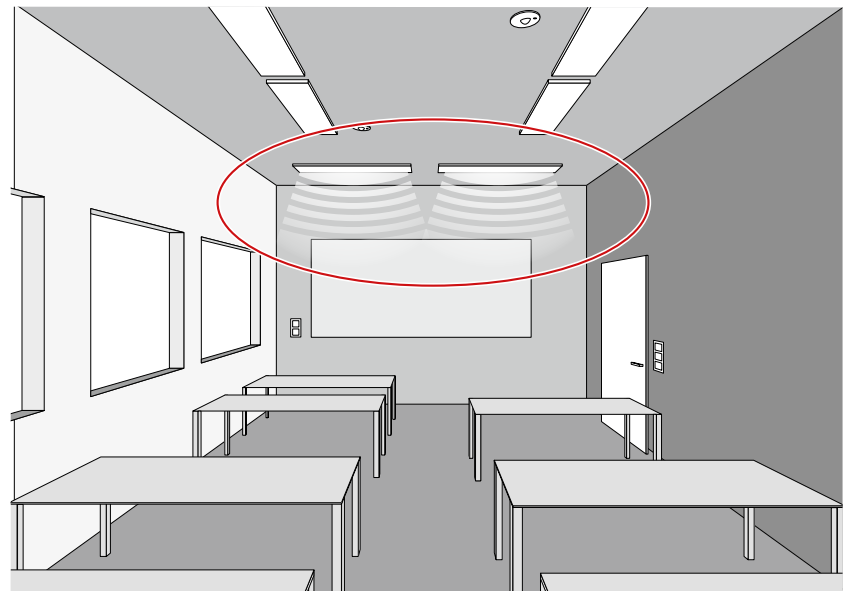
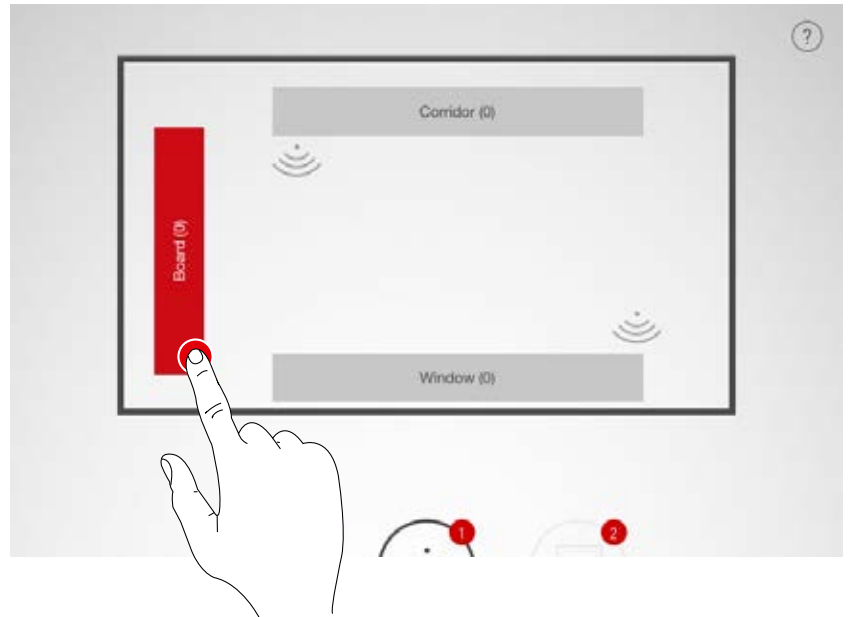

Removing luminaires from a group

A long tap opens a window that shows all luminaires which have been assigned to this group. The individual luminaires can be identified by tapping them and can be deleted by subsequently tapping the delete button.

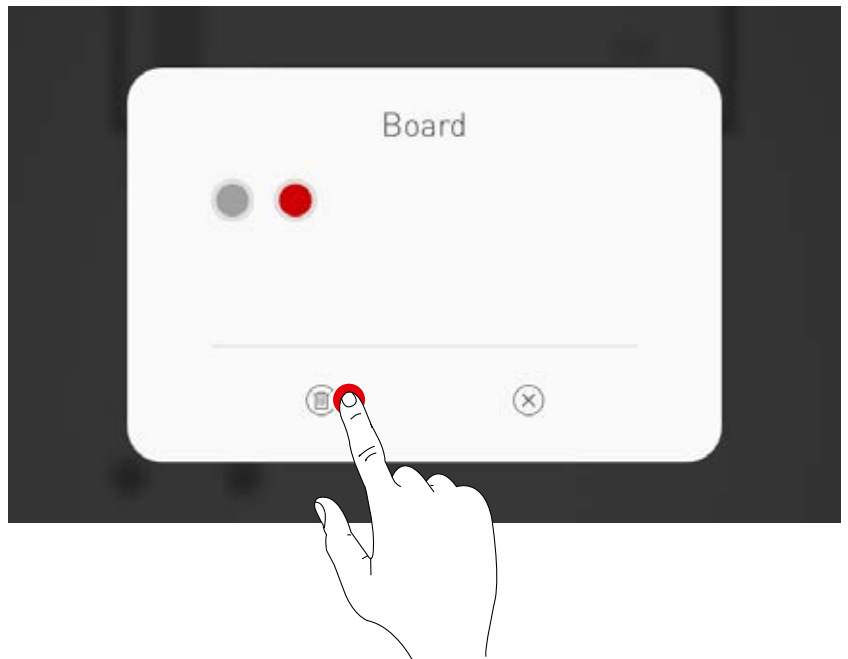
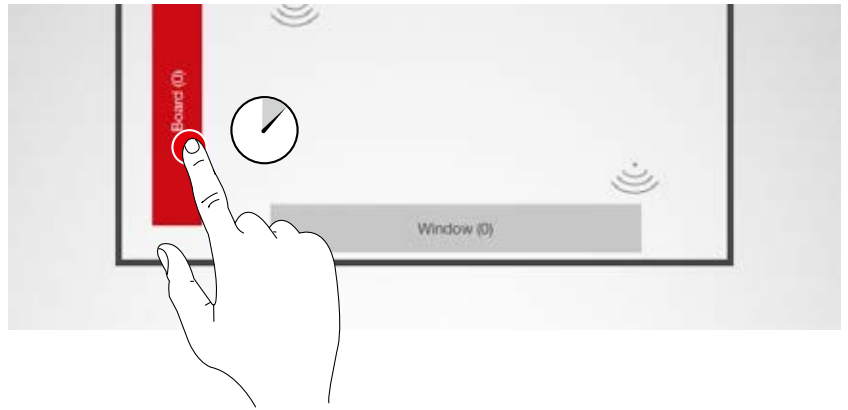

Concluding the luminaire assignment

Additional luminaires can be assigned, either individually or several at a time. It should be noted that not all luminaires need to be assigned and not all luminaire groups need to be used.

Assigning sensors

The assignment is performed analogue to the luminaire assignment. In this, the control lamp of the sensors serves for identification purposes..



Sensor functions

Subsequent to a long tap on a positioned sensor, different functions can be called up.

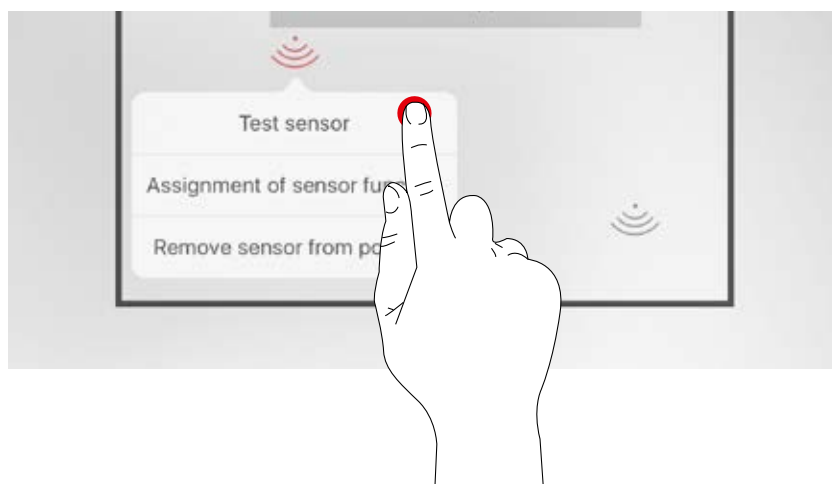
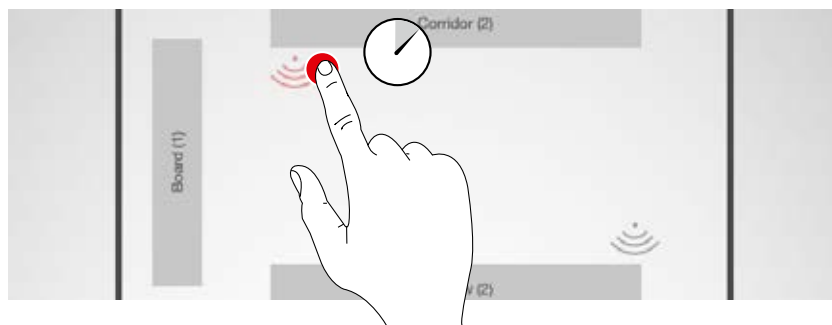

Testing the sensor

The function "Testing the sensor" shows detected movements. This way, the function of the sensor and its detection range can be tested.

Setting the "Dual HF" sensor

If a Dual HF sensor is utilised, the detection range can also be adjusted here.

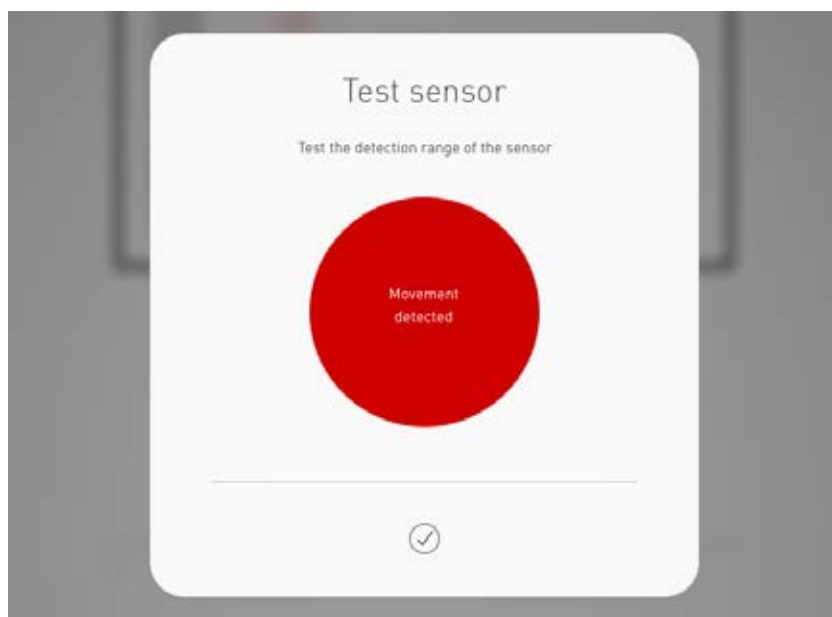

Remove sensor from position

With this function, a sensor can be removed from the position. It is then available again in the bottom area of the screen for a renewed assignment.

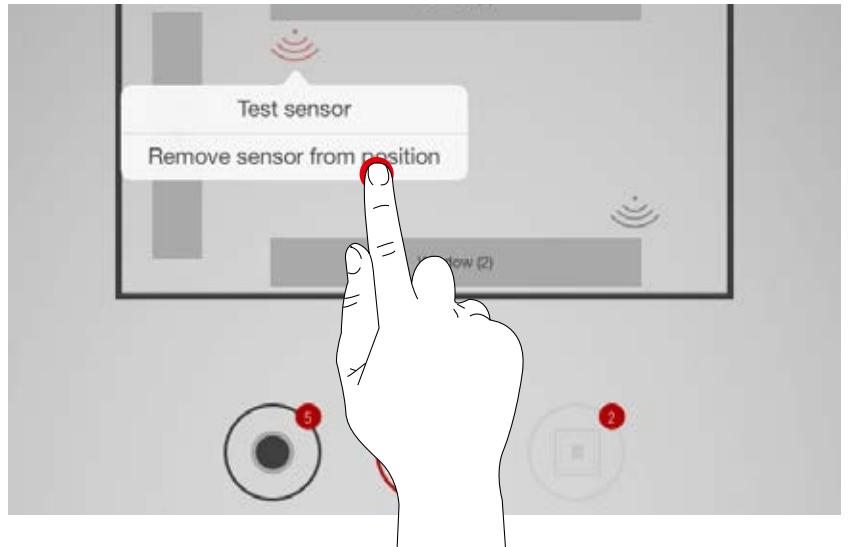

Assignment of sensor function

This function enables assignment of presence detection or constant light detection to the various luminaire groups.

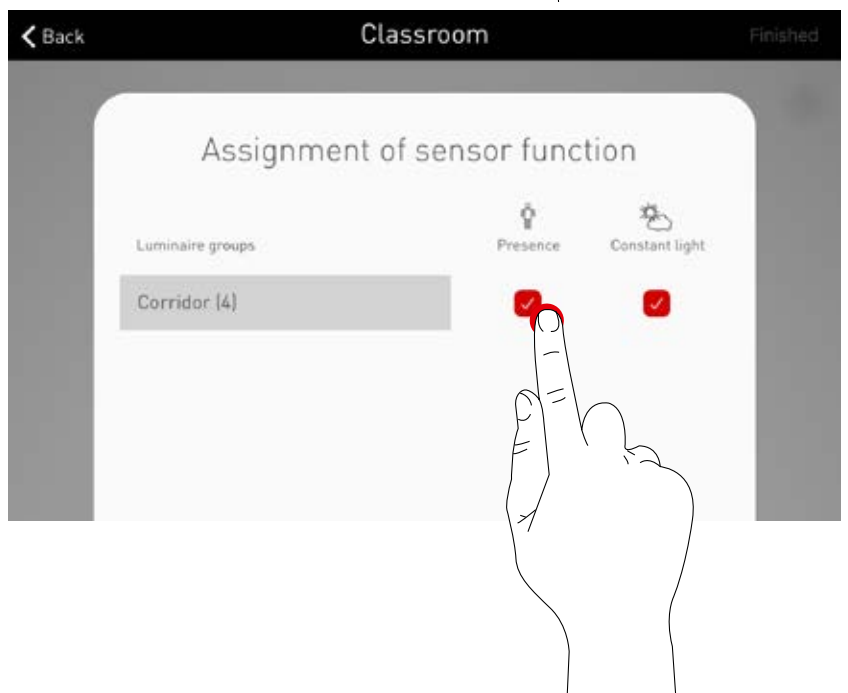
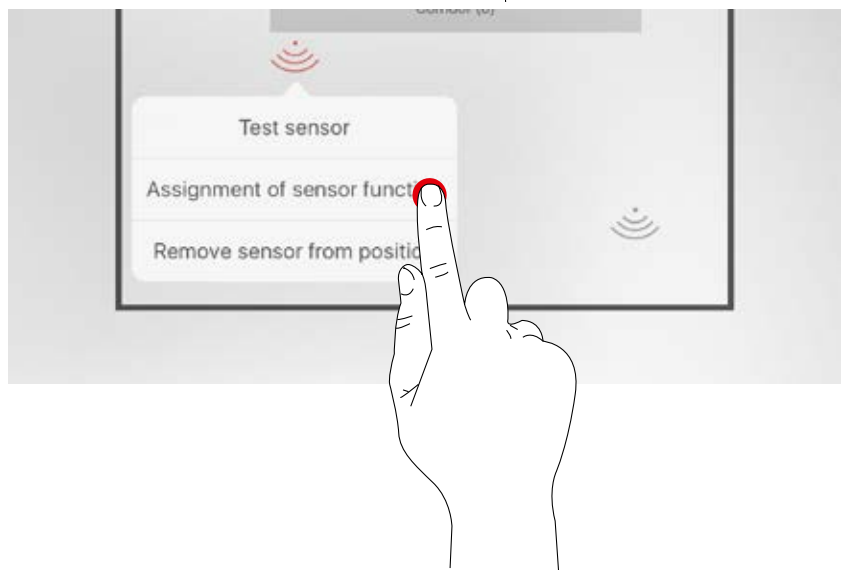

Push-buttons

The push-buttons are set up only in the next steps. Both the connected push-button couplers as well as the push-button on the control device are displayed. The number of all connected push-buttons is NOT displayed.



ROOM SETUP: MANAGE SCENES

In this screen, light scenes can be set up and managed.

Typical scenes are included in the Use Case delivery. Additional scenes can be created completely from scratch or duplicated from existing scenes. Of course, all configuration options are available in either case.

A light scene consists of dimming settings for the individual luminaire groups as well as sensor options. Depending on the equipment, the sensors can be utilised for presence detection and/or constant light control. Different sensor settings are available for both modes of operation.

1. Creating the lighting settings for a scene

2. Setting the sensor system for a scene

New scenes can be created and configured by tapping the plus symbol.

The dimming value of the individual groups is specified in percent. A group is activated by tapping it and the value can be configured.

Enables access to the sensor options "presence detection" and "daylight-dependent control".

Selecting pre-defined scenes. Pre-defined scenes contain typical settings for light scenes. The default scene is marked with a red dot, for the behaviour e.g. upon switching mains power on.

Control wheel for the **setting of the dimming values of the luminaire groups or of the control parameters for the sensors.**

Control: an asterisk with the dimming level indicates that control is active for this group.

Listing all scenes

In this screen, all existing scenes are listed. With a long tap on a scene, a context menu is opened. Here, the scene can be deleted, edited, copied, or specified as the default scene.

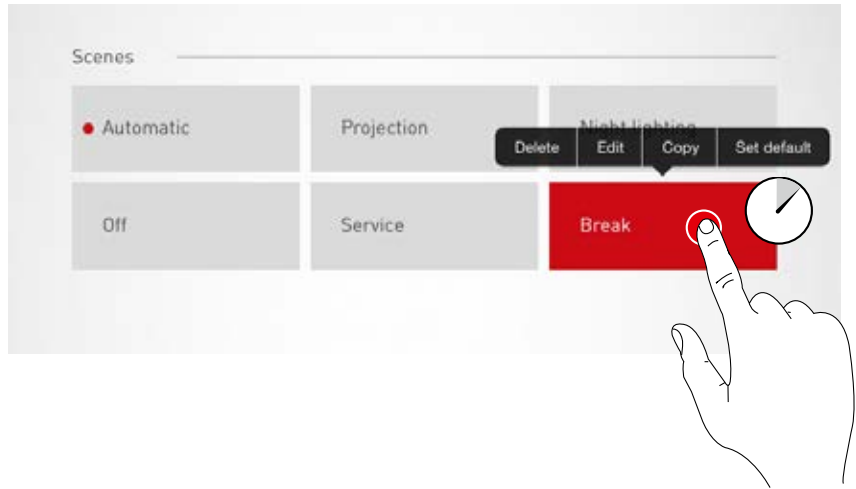

Copy scene

With a tap on "Copy", this scene can be copied with all its settings. In the next step, a new name is assigned. The subsequent steps guide through the setup of the new scene; they are identical to the standard setup steps for new scenes which are described on the following pages.

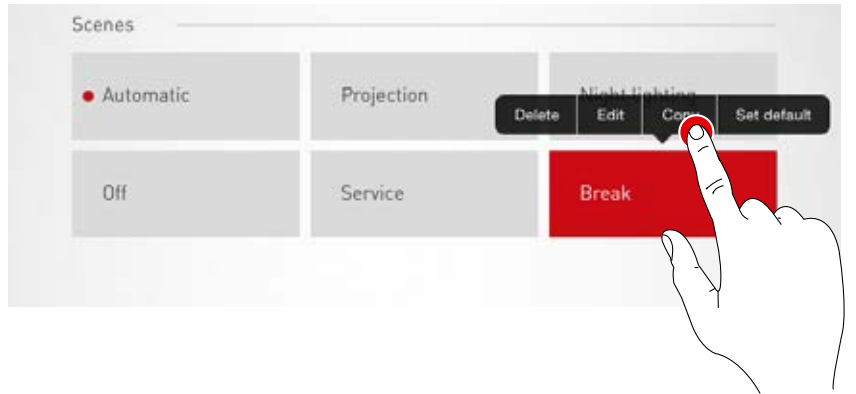

Edit scene

Tapping on "Edit" starts the editing of the scene. The subsequent steps are identical to the standard steps for the setup of new scenes which are described on the following pages.



Set default scene

The default scene is activated automatically every time the system is switched on. By tapping "Set default", this scene can be specified as the default scene. A red dot in front of the scene names indicates that this is the default scene.

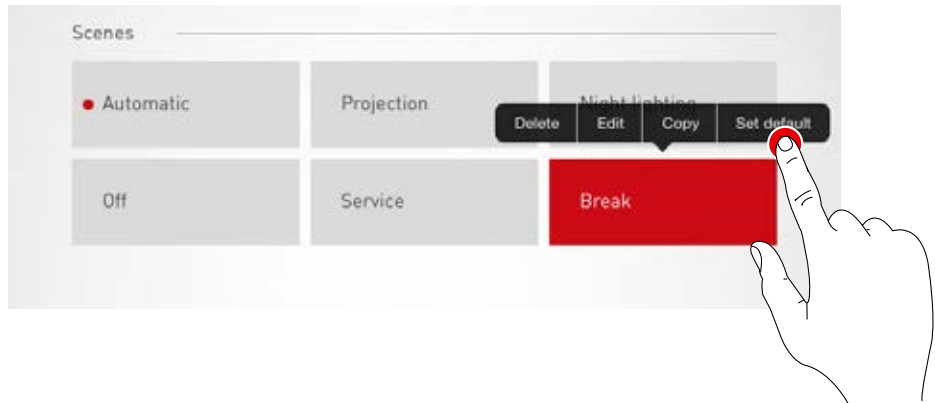

Creating a new scene

A tap on the plus symbol starts the setup process for a new scene.
On the next screen, the name can be assigned.

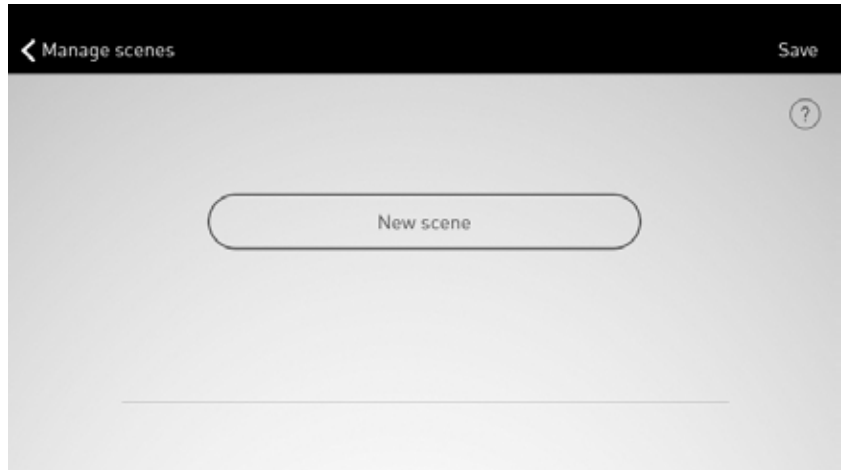
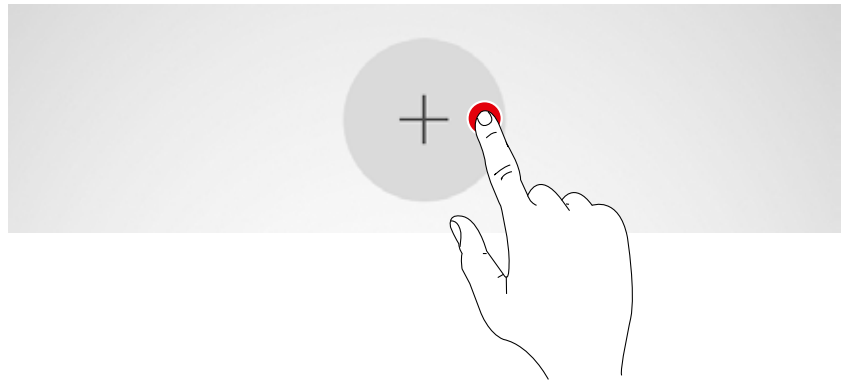

ROOM SETUP: SETTING UP SCENES

In this screen, dimming values as well as sensor options can be adjusted.

Selecting luminaire groups

A luminaire group is activated by tapping on it; an active luminaire group is shown in red. Multiple luminaire groups can be activated one after another in order to configure them at the same time.

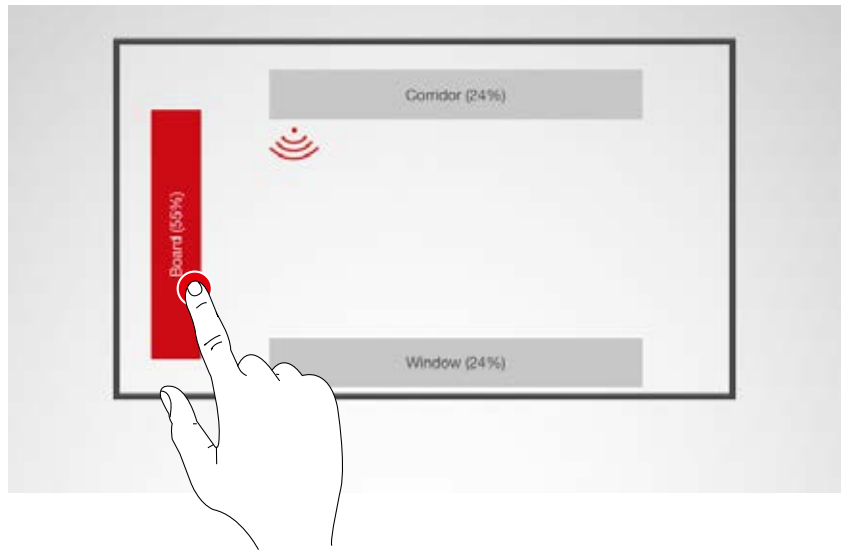

Specifying the dimming value

The activated luminaire groups can be dimmed to the desired level with the control wheel.

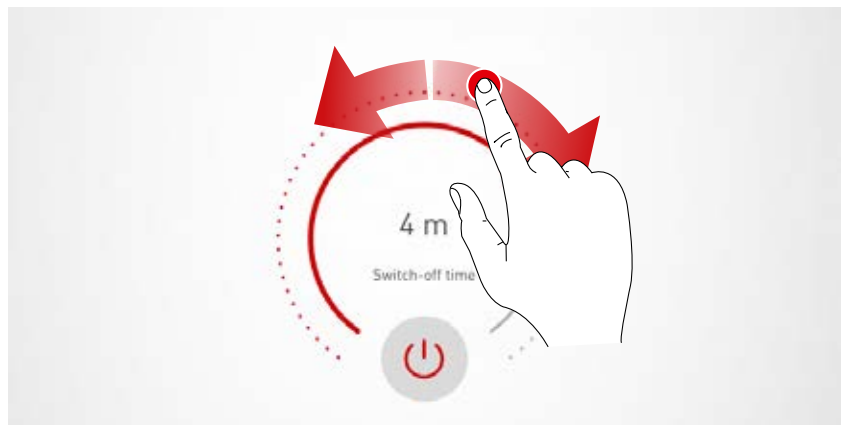

Configuring a sensor

By tapping a sensor, the sensor functions are displayed. Depending on the sensor utilised, a presence detection and/or a constant light control can be configured. Subsequent to the selection of a function, the luminaire groups linked with this function are highlighted red. The assignment of the sensor controls to the luminaire groups takes place in the luminaire assignment (see chapter "Room setup: Assignment").

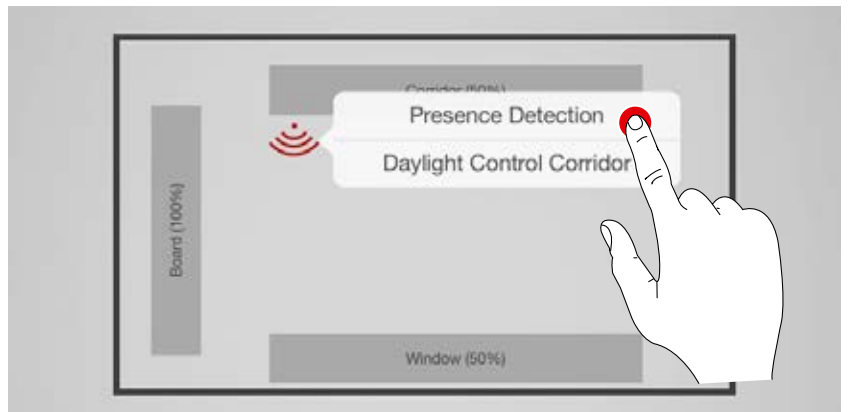
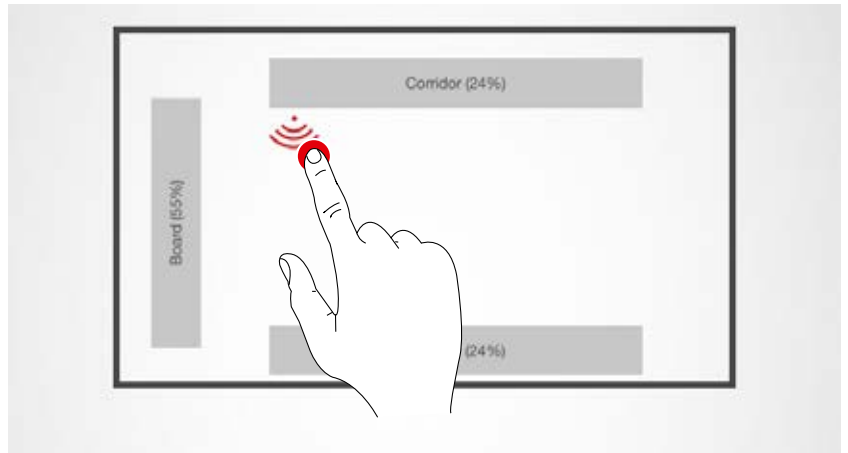

Setting up presence detection

Tapping on the sensor symbol (at the control wheel) activates/deactivates the sensor. The switch-off delay can be set with the control wheel.

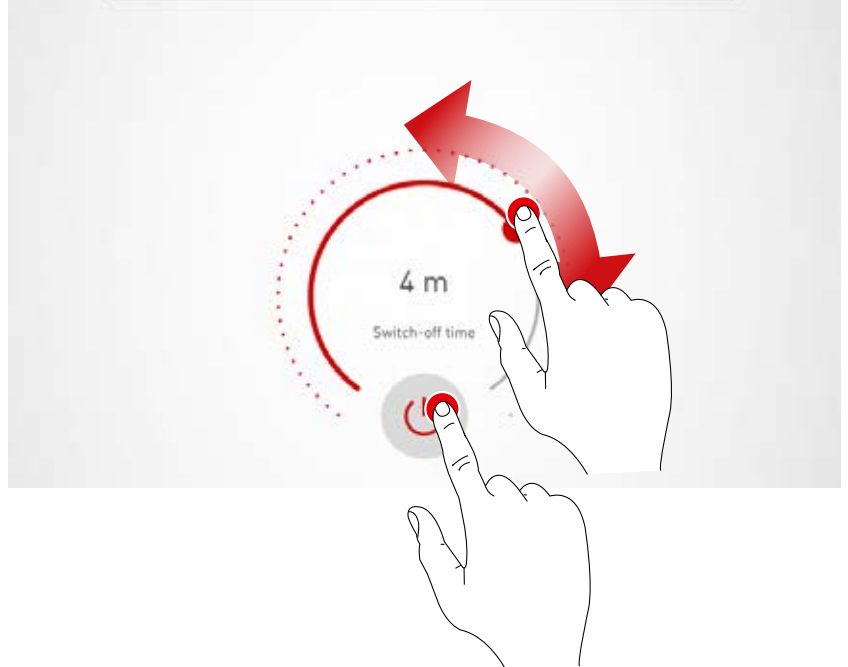
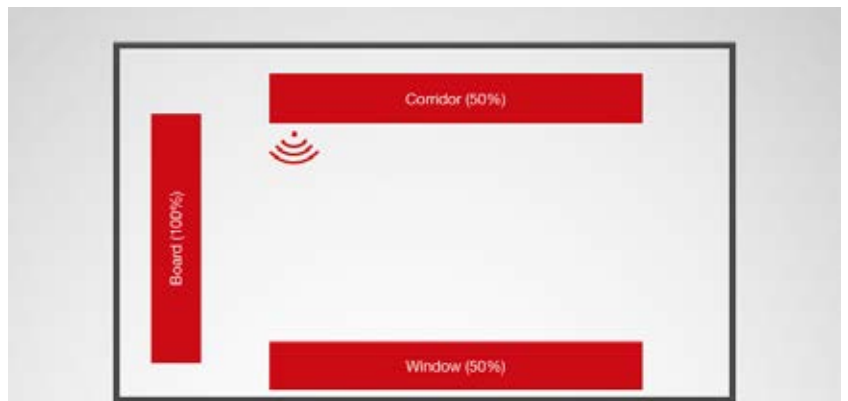

Presence detection: IQ mode

If the switch-off delay is set to "0" with the control wheel, the IQ mode is activated.

The IQ mode analyses the utilisation of the room based on the detected movements.

In IQ mode, the delay period is between 5 and 20 minutes.

If a lot of movement is registered, the delay period doubles, if hardly any movement is registered, the delay period is halved.

In case of constant utilisation of the room, this will, for example, result in the lighting not being shut off directly when somebody leaves the room or if any of the occupants do not move for a while. But if the room is used only sporadically however, the delay period is automatically reduced to 5 minutes.

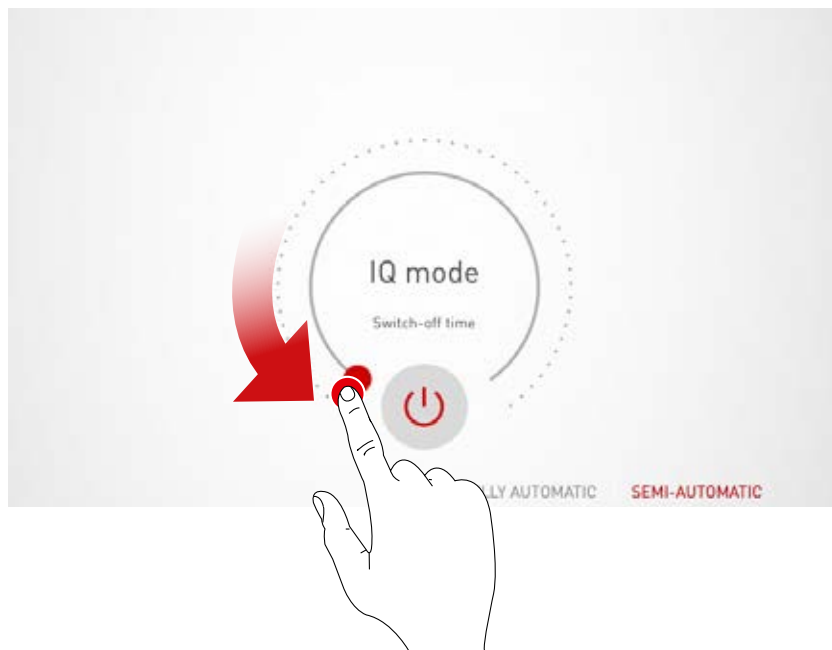

Presence detection: Fully automatic

The lighting is switched on and off automatically, depending on brightness levels and presence detection.



Presence detection: Semi-automatic

The lighting is only switched off automatically in this case. The switching on is performed manually.

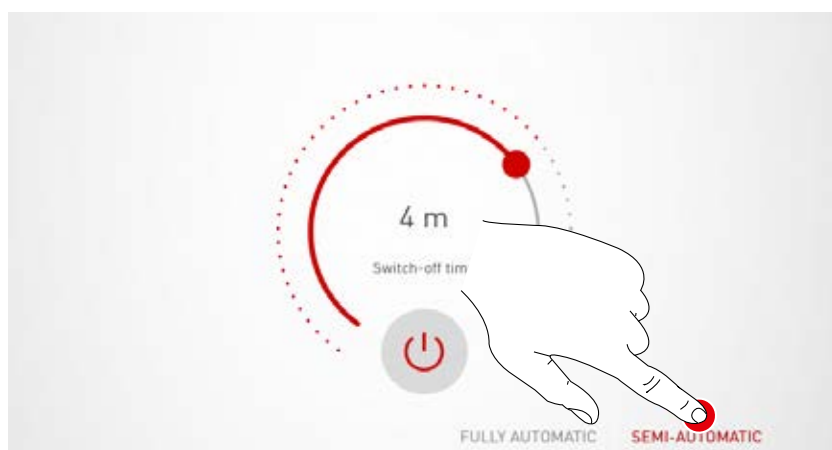

Setting up constant light control

In the case of constant light control, the sensor continuously measures the level of brightness in the room. The automatic control adjusts the brightness of the lighting in order to compensate for the changes in the levels of exterior light. This way, it ensures a constant brightness at the highest level of efficiency.

Subsequent to selecting constant light control, the desired brightness level for the room can be set via the control wheel and stored as a nominal reference value.



Constant light control: In calibrating the light control, the following points must be taken into consideration:

- The calibration of the lighting should be performed with as little daylight as possible.
- Sources of interference and the casting of shadows on the area to be calibrated must be avoided. (See chapter "Sensor placement")

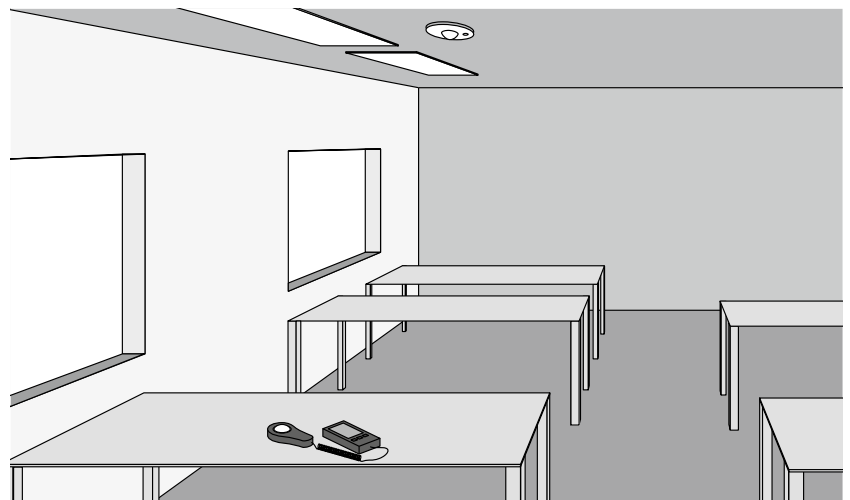

Constant light control: Setting the offset

For a uniform and efficient illumination, it may be sensible to undertake a separate control of luminaires that are close to the window and that are far from the window.

If only one sensor is available, an offset setting may be applied:

Once the constant light control has been activated, the luminaires that are linked to this function are highlighted red. By tapping the luminaire groups, these can be activated and/or deactivated and as such, different target values can be set.

Caution: The target values are set for the condition of maximum incident daylight. If daylight is available during the setup, the target values can be adjusted optimally while observing the light distribution. If no daylight is available, the target values must be estimated.

Caution: For separate control of luminaires close to the window and luminaires far from the window, an individualised control with multiple sensors which adjust the different luminaire groups separately is better suited.

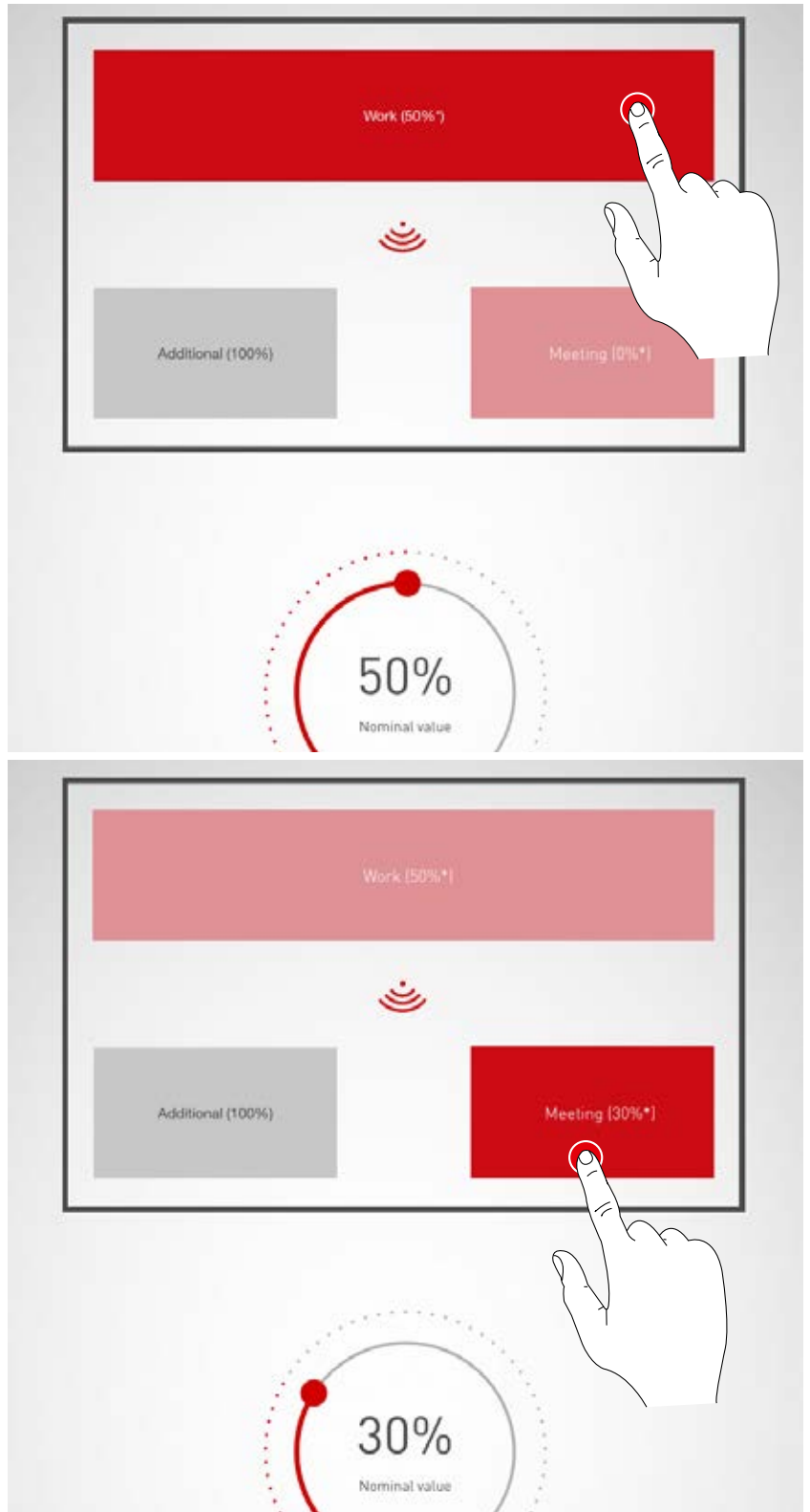

ROOM SETUP: ASSIGNING PUSH-BUTTONS

1. Assigning push-buttons

In this screen, the push-buttons are connected to a light scene or a luminaire group

If a light scene is assigned to a push-button, this light scene is activated later upon pushing the button.

If a luminaire group is assigned to a push-button, the respective luminaire group is dimmed or switched later upon pushing the button (touch/dim function).

Only one single light scene can be assigned to a push-button. But not all push-buttons and light scenes need to be linked.

New push-button assignments can be created by tapping the plus symbol.

Choose between scenes and luminaire groups.
A push-button either activates a light scene or switches a luminaire group on or off, respectively.

Listing of all push-button assignments set up

Labelling the push-button assignment

Testing the scene
Subsequent to a long tap on a scene, it can be activated for a test.

Selecting the light scene or luminaire group, respectively.

Listing of all push-button assignments

In this screen, all existing push-button assignments are listed. By swiping to the side, the assignment can be deleted.

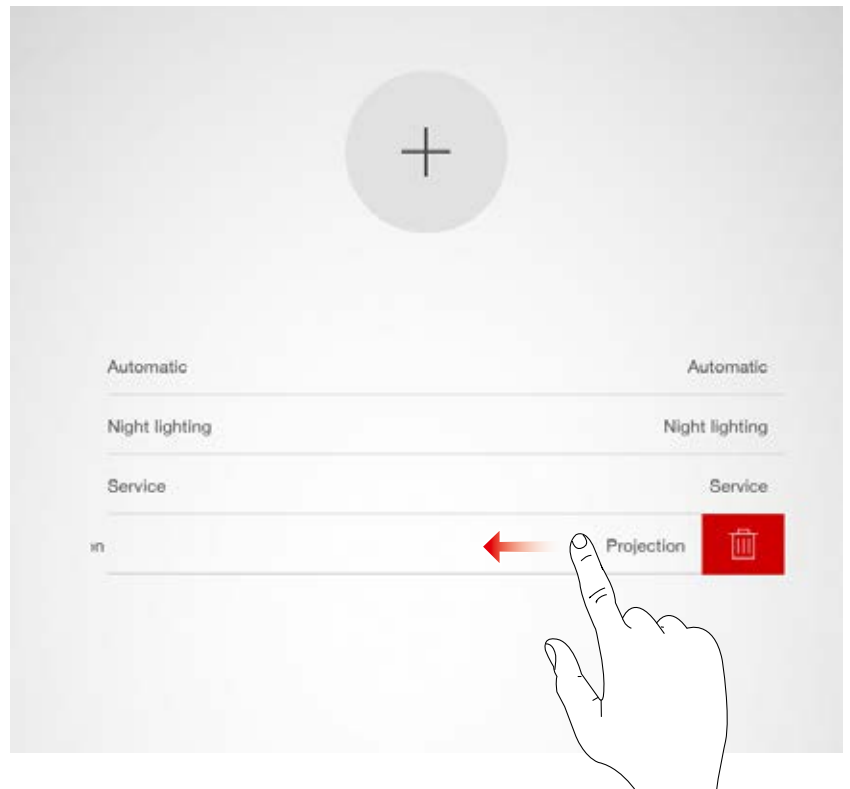

Creating a new push-button assignment

A tap on the plus symbol starts the setup of a new push-button assignment. In the next screen, the name for the assignment can be assigned. The name must be manually assigned for light group push-buttons.

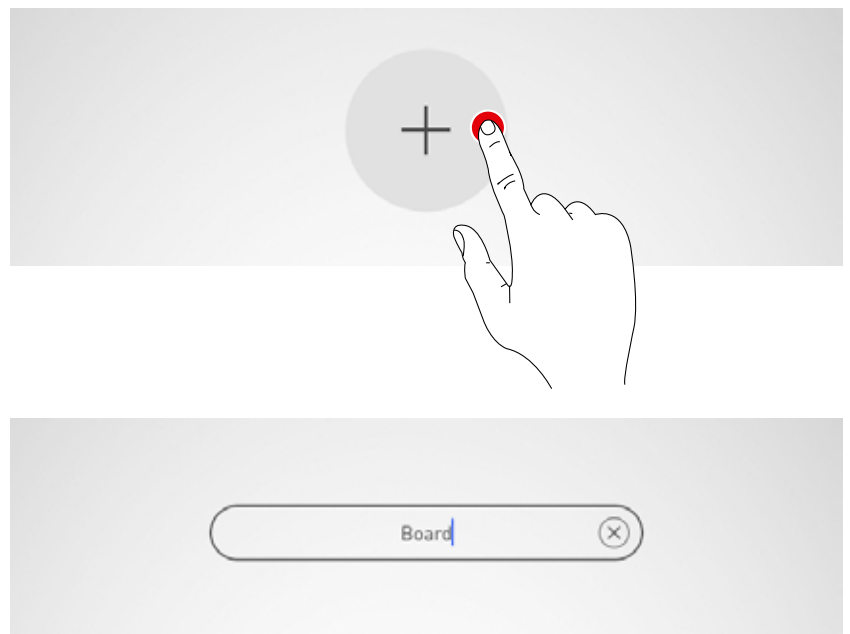

Selecting scenes / luminaire groups

Firstly the user needs to select whether the push-button is intended to call up a light scene or to switch and dim a luminaire group. Depending on the selection, all light scenes or all luminaire groups are then listed respectively.

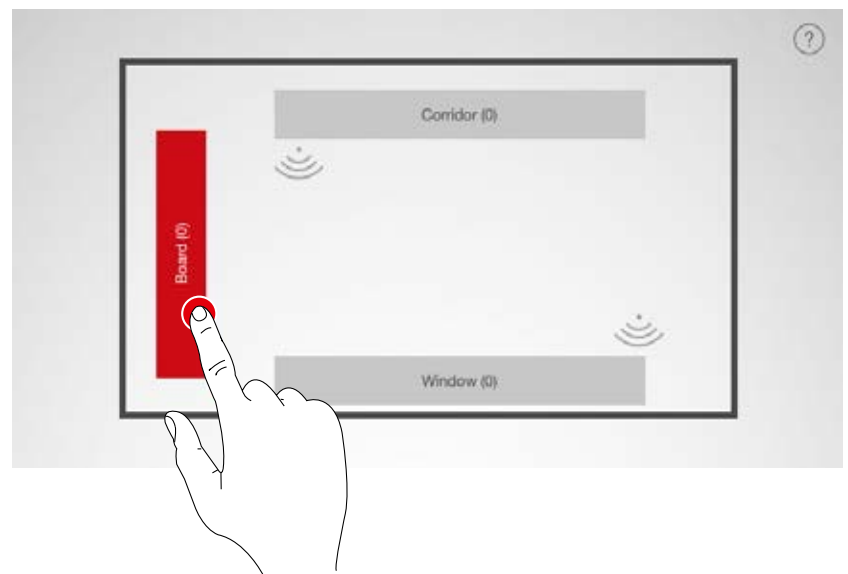
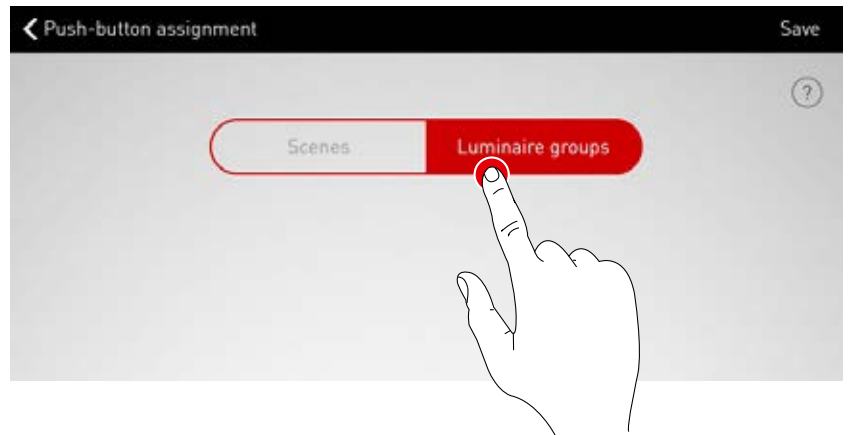

Memory Mode

In case a push-button has been assigned to a group of luminaires, the „Memory Mode“ function can be selected. If Memory Mode is activated, the group of luminaires will be switched on with the last dimming value. If Memory Mode is deactivated, the group of luminaires is always switched on with 100 % lighting.

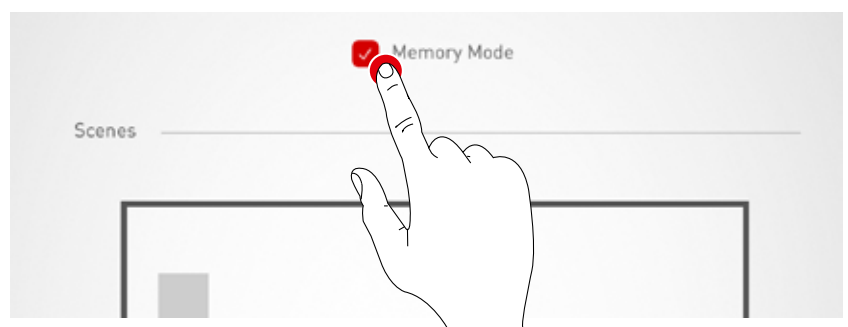

Assigning push-buttons

After the scene or luminaire group has been stored, a window signals that LiveLink is now waiting for the assignment of the push-button. The respective push-button must then be pushed and held (for up to 5 seconds) until the assignment is confirmed in the window.

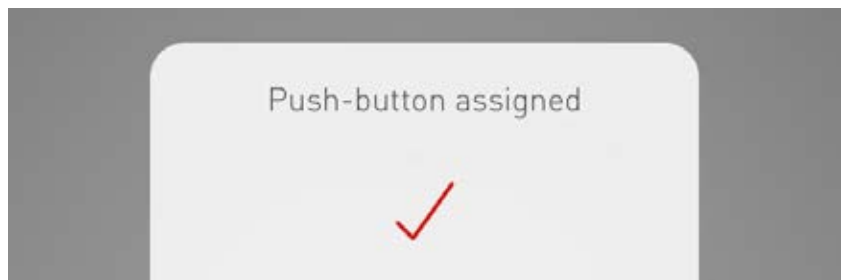
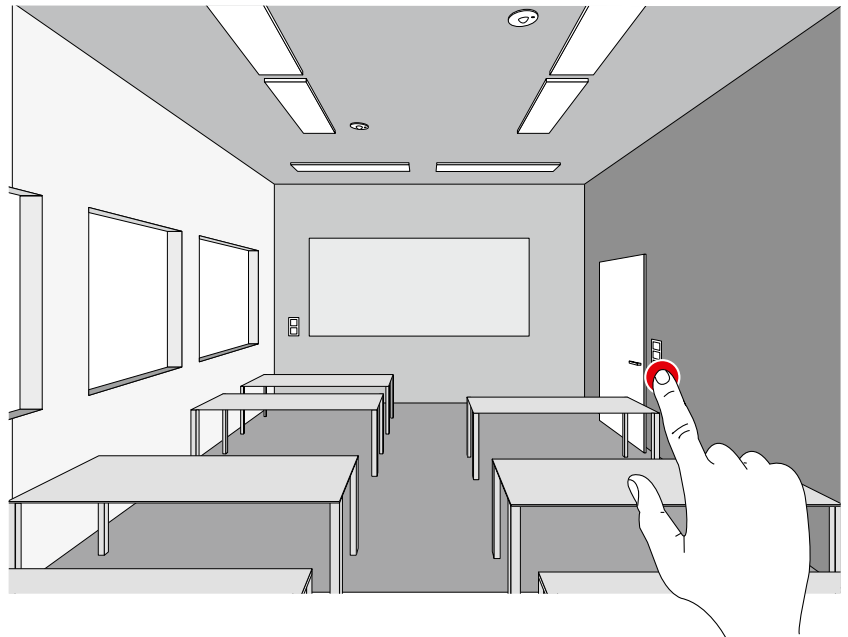

Additional push-button assignments and overwriting assignments

The push-button assignment is concluded and is listed in the list. Now, additional push-button assignments can be added. But not all push-buttons and light scenes need to be linked. If a selected push-button has already been assigned, a note is displayed. At this point, there is the option to overwrite the existing assignment of this push-button.

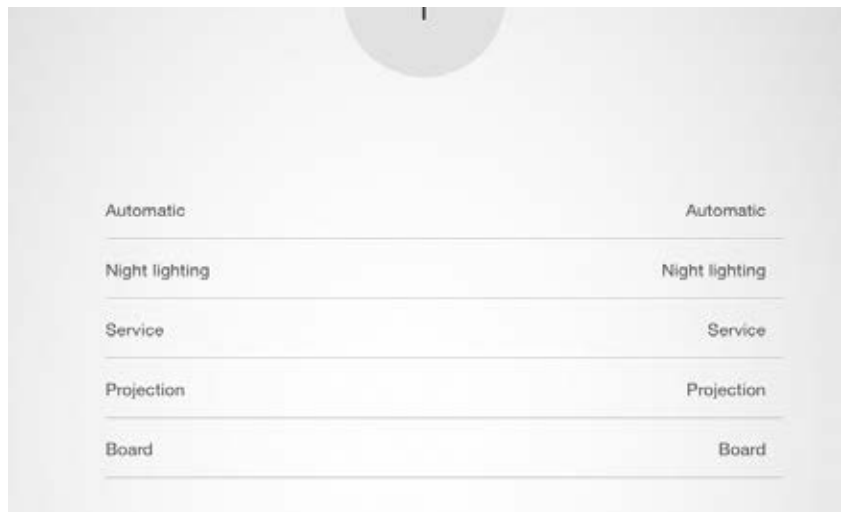

CONCLUDING THE ROOM SETUP

1. Specify user password

Upon conclusion, a user password must be specified and after a summary has been checked, the room setup is concluded.

Specify user password

Subsequent to the completion of the push-button assignment, a password for user access must be specified.

The password serves for light control by the end user via the "LiveLink Control" app.

Caution: Remember the password!

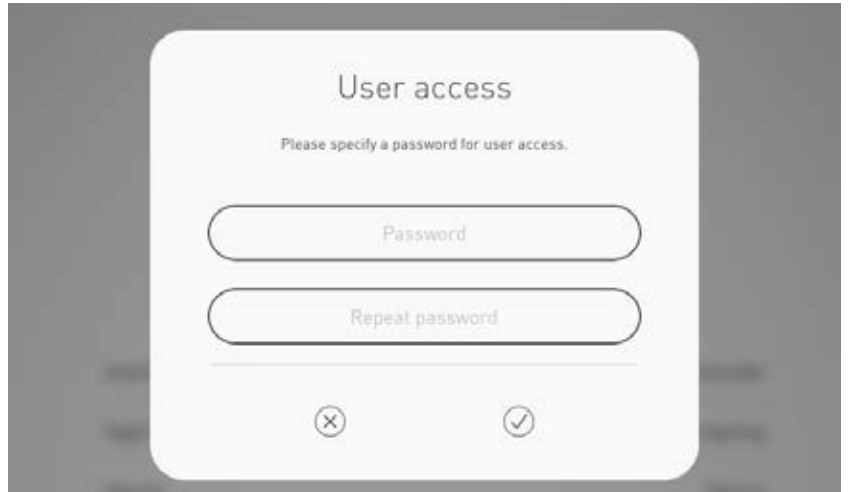

Check the summary and apply optional settings

In this view, the room setup can be checked based on a summary.

If changes are necessary, it is possible to jump back to the preceding steps via the navigation in the title bar.

If no changes are necessary, the room setup is concluded.

Applying option settings

Optional setting steps are also available here enabling the room to be renamed and the LiveLink system to be connected to a KNX system.

An acceptance log can be exported with the „Generate PDF“ function.

Operating these functions is described in the „Room management“ section.

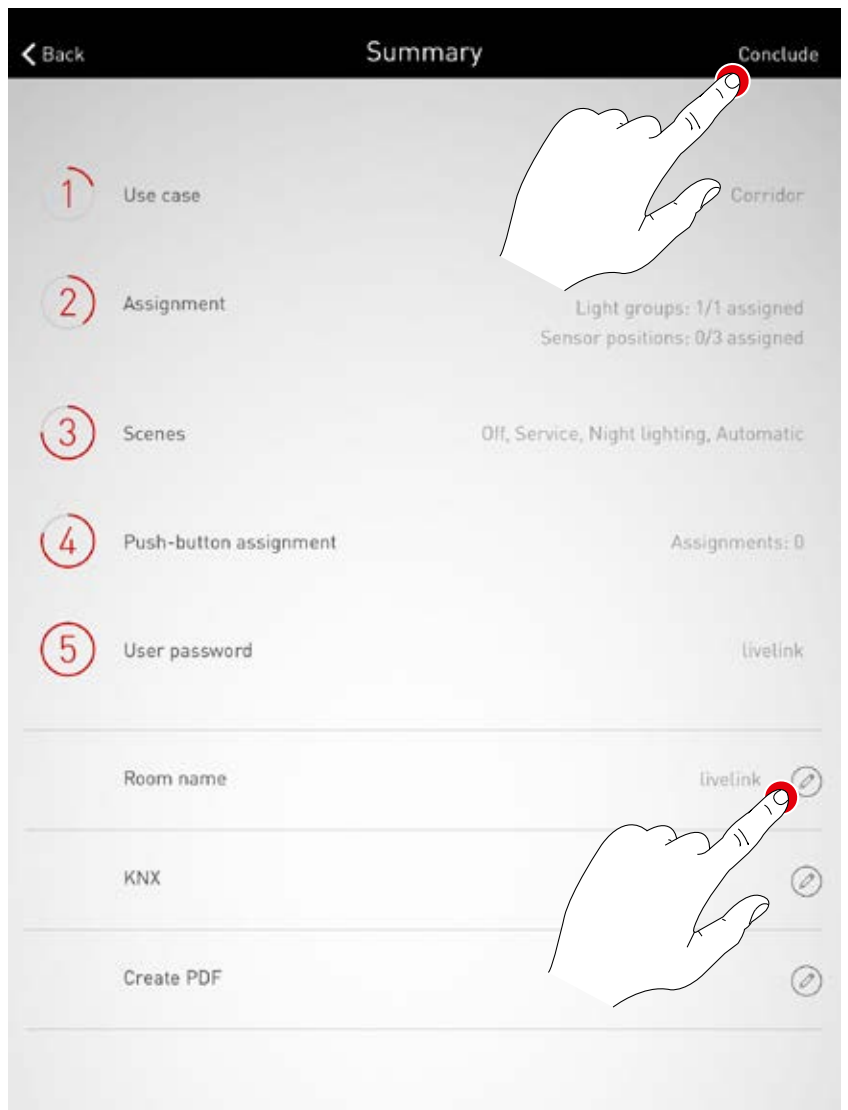

ROOM MANAGEMENT

In the room management screen, all aspects of the room setup can be called up adjusted, as required. The operation of this menu is identical to the initial setup and will not be explained further here.

Select Use Case

Selecting a matching Use Case

Assignment

Assignment of luminaires and sensors

Manage push-buttons

Manage the assignment of push-buttons to luminaire groups and/or light scenes.

Manage scenes

Management of existing light scenes from the Use Case as well as the setup of individualised light scenes.

Renaming a room

Changing the name of the room. N.B. The Wi-Fi network name is adapted to the changed room name.

KNX

Set up the connected KNX interface. Establish links for scenes, luminaire groups, push-buttons and sensors between LiveLink and KNX.

Overview

Display of all implemented programming.

Basic lighting

Setting up a basic lighting function.



ROOM MANAGEMENT: RENAME ROOM

In this screen, the room name can be changed. The name the room is given is adopted as the Wi-Fi network name and as also as the room name for utilisation in the apps.

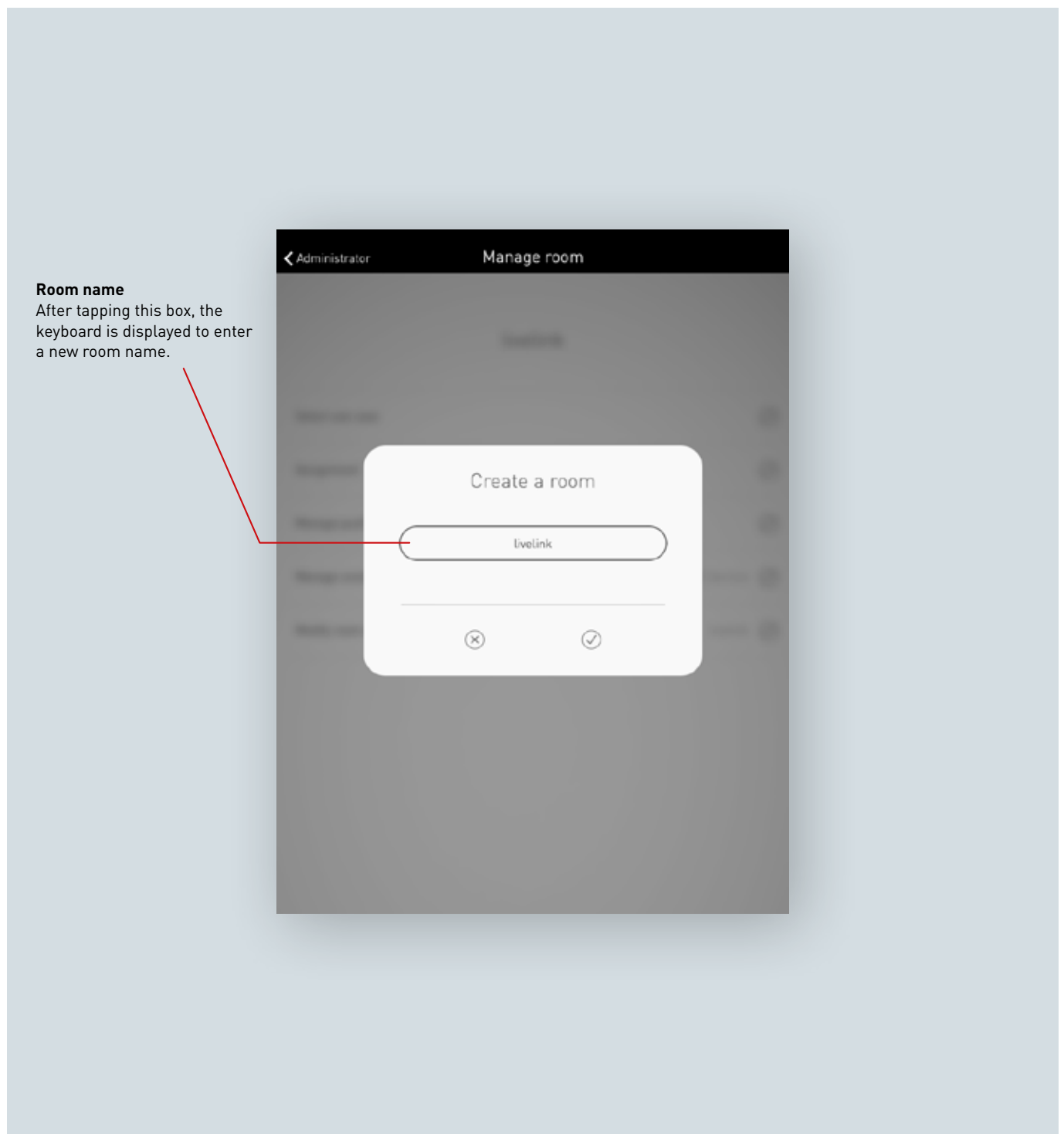

Change room name

After tapping "Change room name", a new room name can be entered.



Reconnecting the Wi-Fi

By renaming the room name, the Wi-Fi also adopts this room name automatically. Therefore, the Wi-Fi network connection must be re-established.

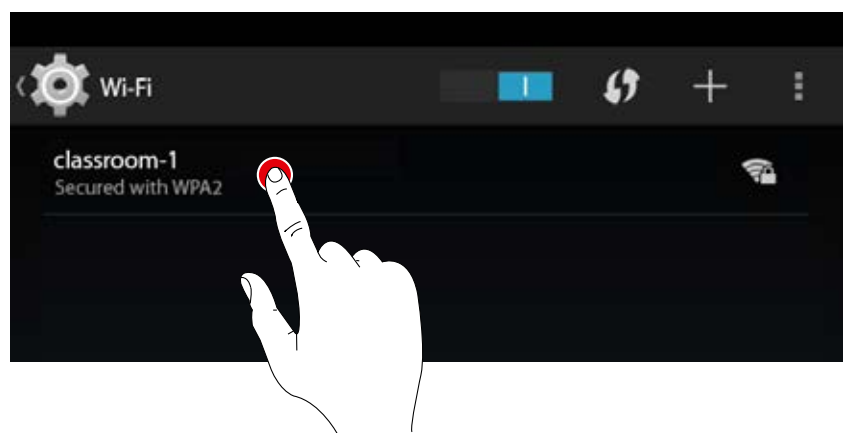
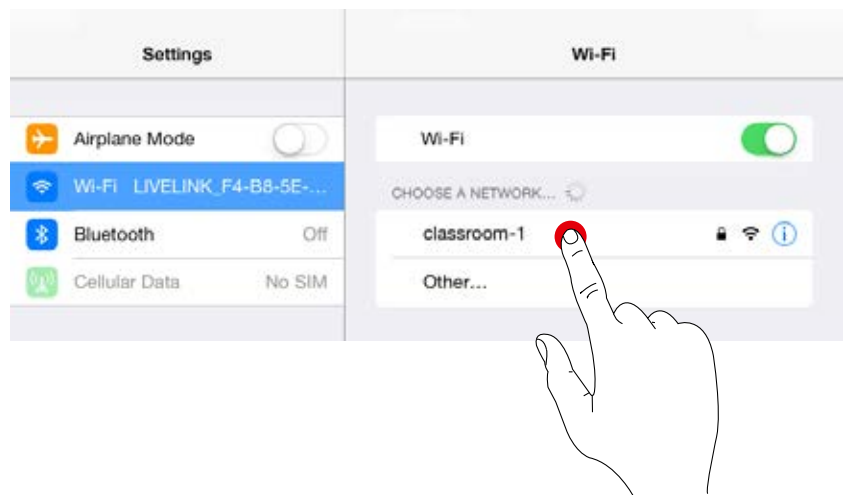

ROOM MANAGEMENT: BASIC LIGHTING

For increasing safety and comfort, the lighting can also be combined with a basic lighting function. This makes sure that the lighting is not switched off with absence but is dimmed down to a settable basic lighting level. Various modes allow time intervals or time windows to be taken into account.

In addition to maximising comfort and energy efficiency, the basic lighting also increases safety and security. It can be used as switch-off prewarning as often required in corridors and stairways.

Permanent

After exiting the room the lighting is permanently dimmed down to basic lighting level.

Time interval

After exiting the room the lighting is permanently dimmed down to basic lighting level for a settable time period. The lighting is only switched off after this time has expired.

Time

With absence, the lighting is dimmed down only in settable time windows to basic lighting level. The lighting is switched off outside these time windows.

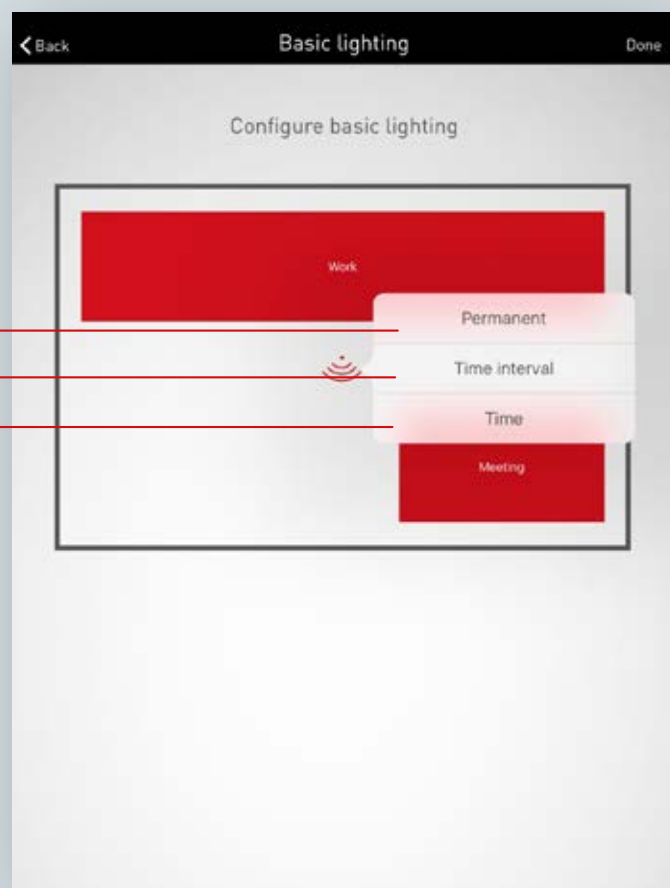

BASIC LIGHTING: PERMANENT

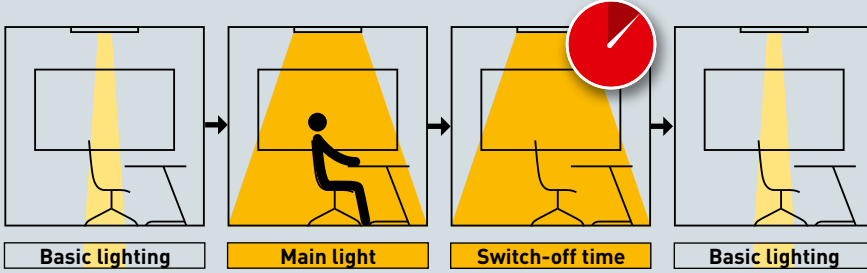

The room is continuously illuminated with basic lighting.

The system changes to main light as soon as motion is detected.

After expiry of the regular switch-off time (in accordance with presence detection) and with no further motion detection, the lighting is dimmed down again to the permanent basic light level.

BASIC LIGHTING: TIME INTERVAL

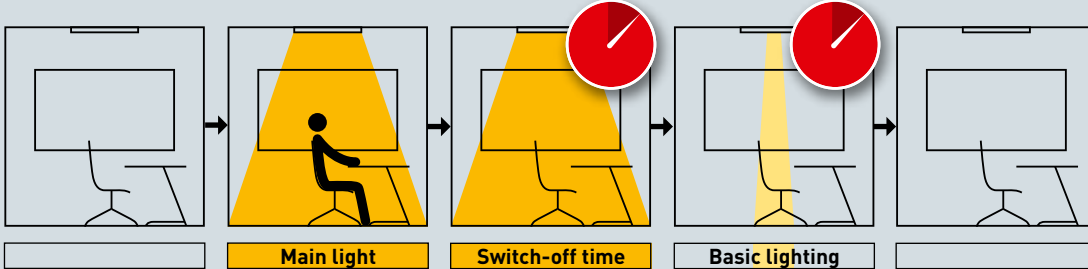

The main light is activated if motion is detected.

After expiry of the regular switch-off time (in accordance with presence detection) and with no further motion detection, the lighting is dimmed down to the basic lighting level. A time interval of up to 60 minutes begins. This function can be used for e.g. switch-off prewarning, as is often required in corridors and stairways.

The lighting is switched off after expiry of the time interval and with no further motion detection.

BASIC LIGHTING: TIME

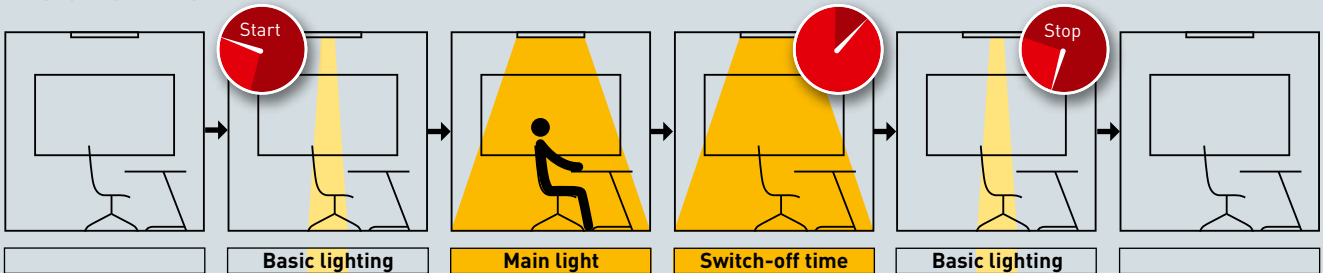

The basic lighting starts at a settable time (several are possible).

The system changes to main light as soon as motion is detected.

After expiry of the regular switch-off time (in accordance with presence detection) and with no further motion detection, the lighting is dimmed down to the basic lighting level.

The basic lighting ends at a settable time (several are possible).

Configure basic lighting

After selecting the „Basic lighting“ function in room management, the room scheme of the configured use case is displayed.

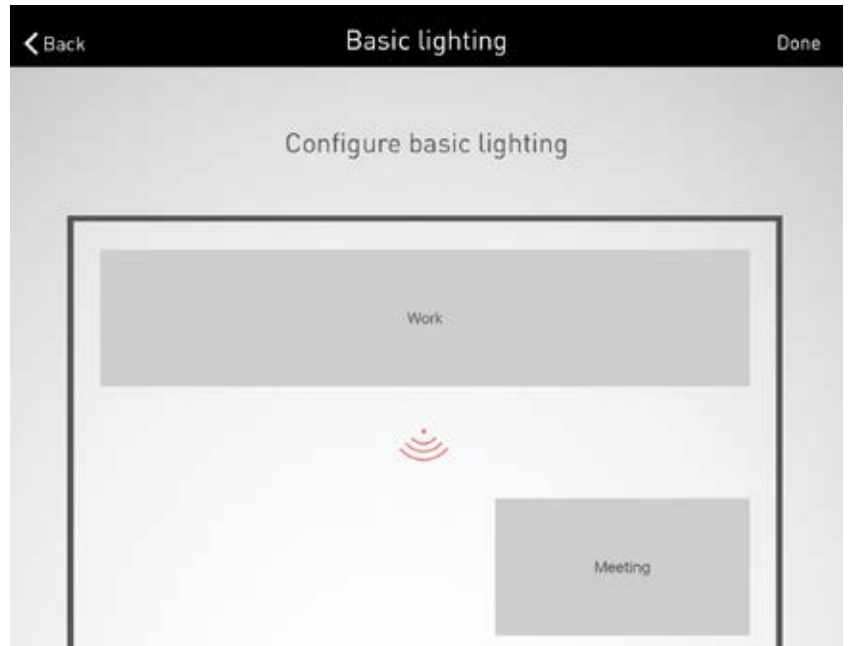

Sensor selection

The sensors, as the central selection element, are shown in red. After tapping a sensor the linked luminaire groups are also shown in red. A list is also displayed for selecting one of the three basic lighting types.

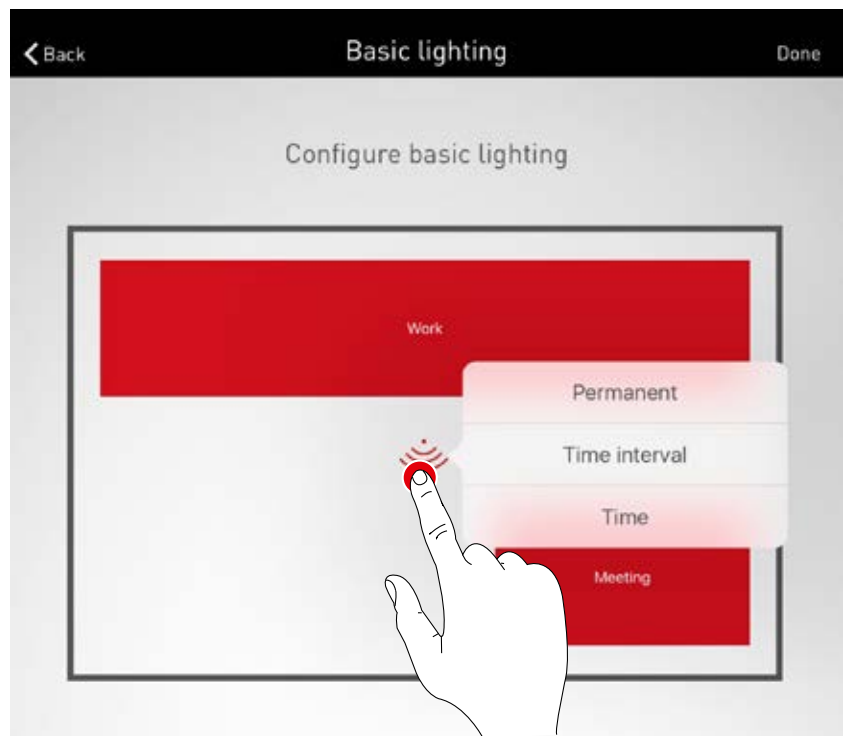

Basic lighting: permanent

After selecting „permanent“ basic lighting, the setting options for permanent basic lighting are displayed below the room scheme:

- Brightness
- Week days

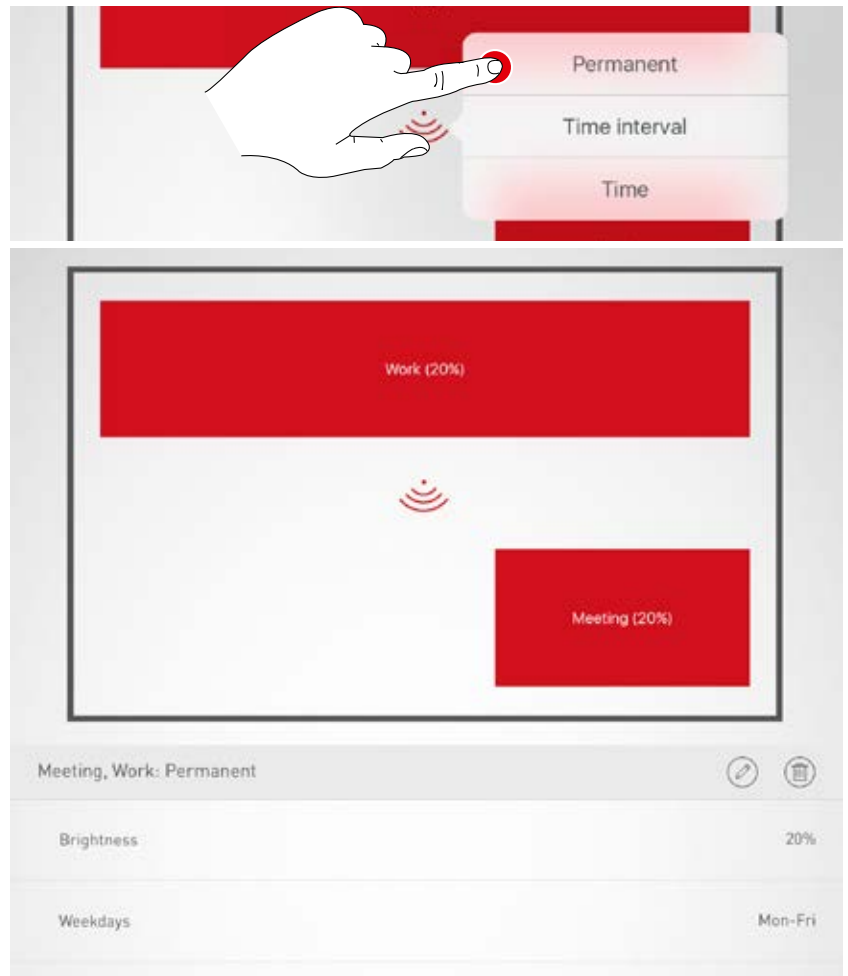

The pre-set dimming value for basic lighting brightness is 20%. A slider then enables the basic lighting brightness to be set to a dimming value of 1% to 60%. The lighting responds directly to this setting and can therefore be observed in the room.

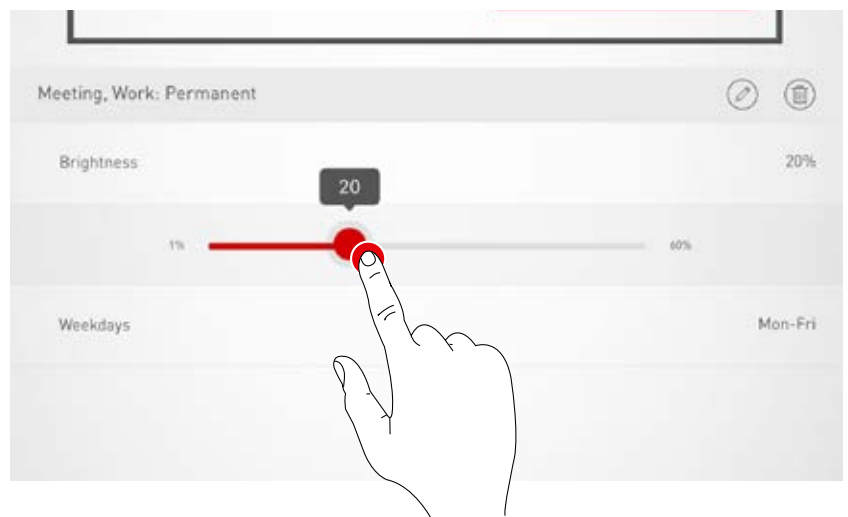

Tapping the week days defines on which days the basic lighting function should be activated. Weekdays Monday to Friday are preset.

The basic lighting setting is completed by tapping on „Finished“ in the menu bar.

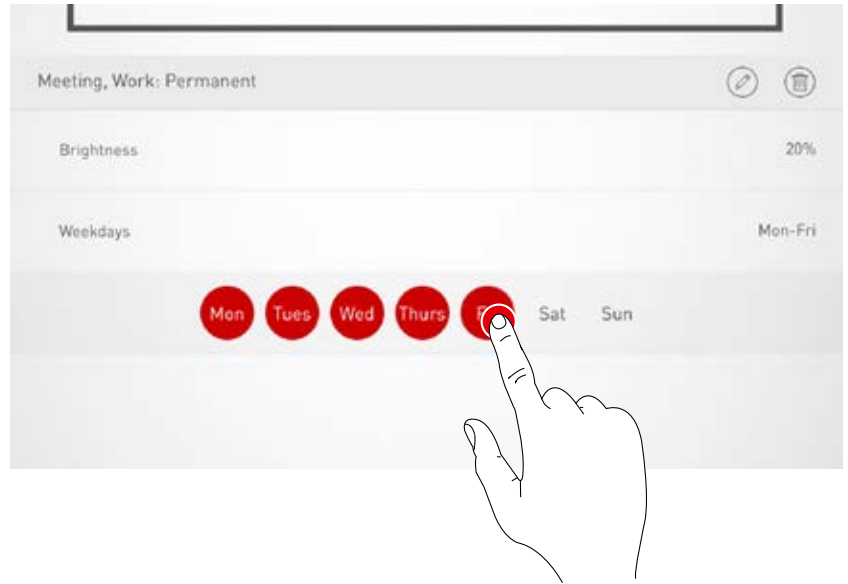

Basic lighting: time interval

After selecting the „time interval“ type of basic lighting, the setting options for time interval-dependent basic lighting are displayed below the room scheme:

- Brightness
- Delay time
- Week days

Setting the „brightness“ and „week days“ functions is carried out in the same way as the „permanent“ type of basic lighting.

The delay time must also be set. The value can be set from 1 to 60 minutes.

The basic lighting is activated after expiry of the switch-off time set for the sensor, and illuminates for the duration of the time interval set here.

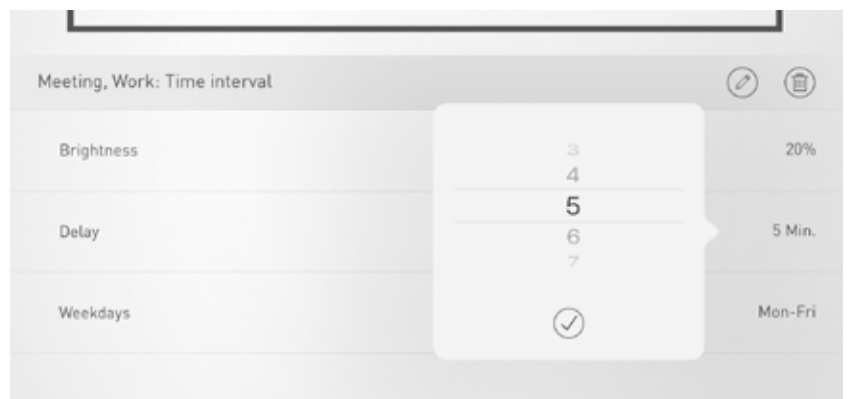
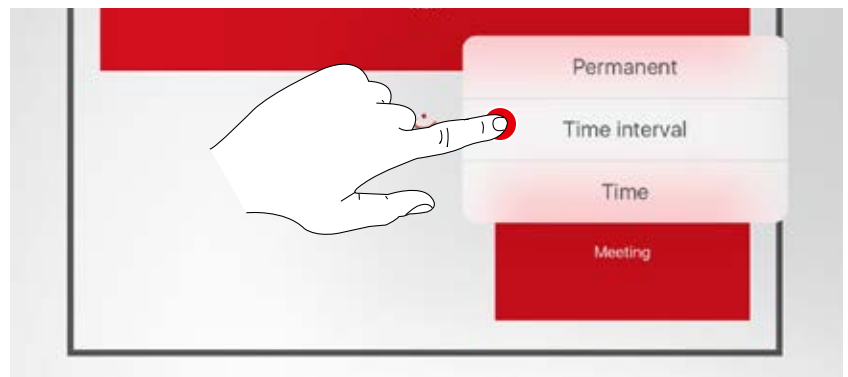

Basic lighting: time

After selecting the „time“ type of basic lighting, the setting options for time-dependent basic lighting are displayed below the room scheme:

- Brightness
- Time
- Week days

Setting the „brightness“ and „week days“ functions is carried out in the same way as the „permanent“ type of basic lighting.

The time must also be set. Several time intervals can be set, for the duration of which the basic lighting is activated.

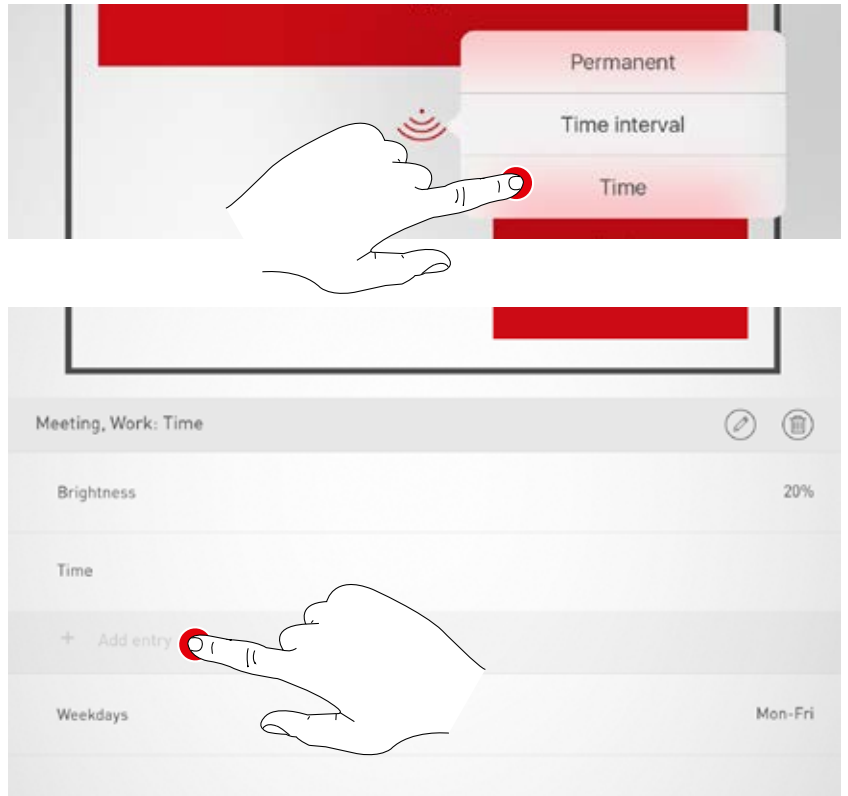

ROOM MANAGEMENT: SET UP KNX

A KNX interface connected to the LiveLink control unit is set up at this location.

Scenes, luminaire groups, push-buttons and sensors are linked step-by-step.

Step 1: KNX interface
Select KNX interface and room.

Steps 2-6:
Link scenes, luminaire groups, push-buttons and sensors.

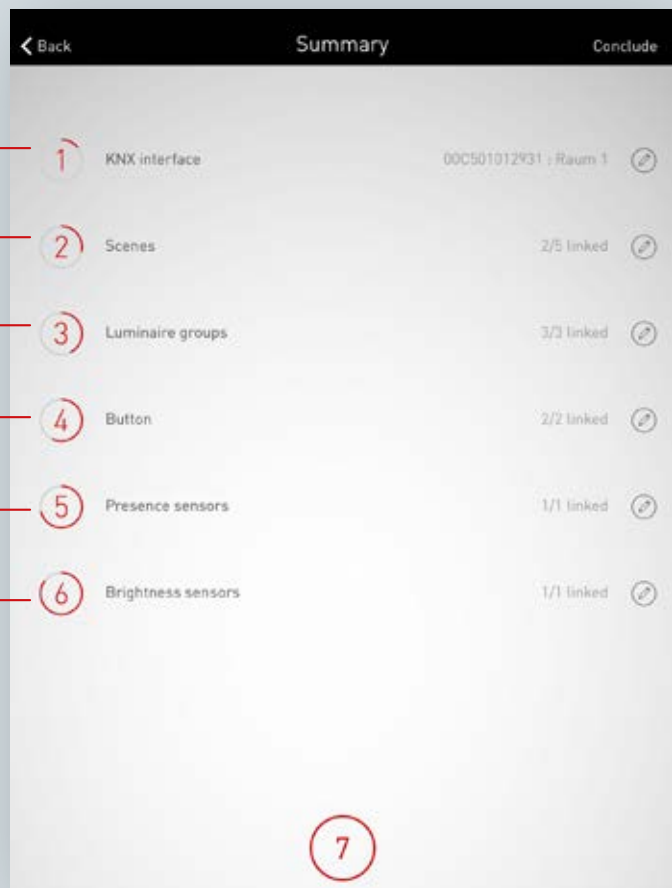

SETTING UP KNX: STEP 1

Select the KNX interface

The available interfaces including serial numbers are listed. The specific interface is selected by tapping its name.

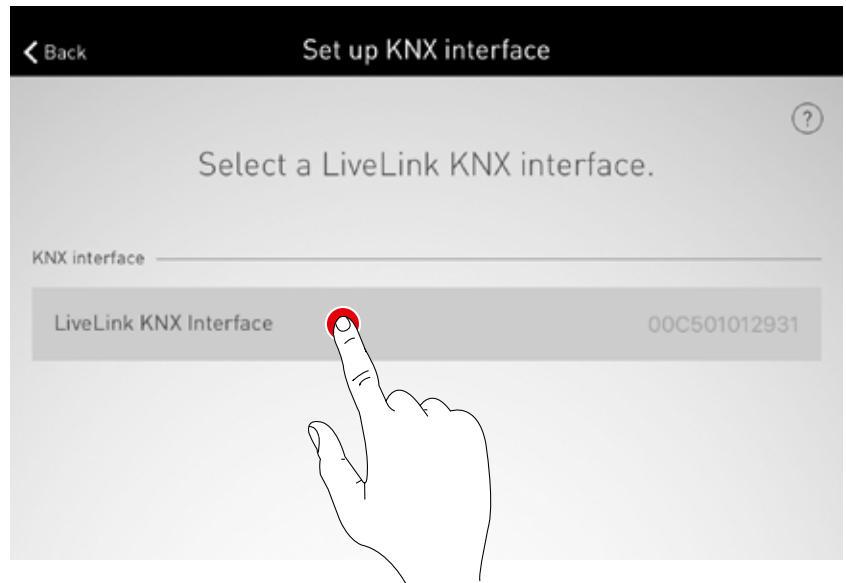

Select the room

This view displays all available rooms for the selected interface. Pre-assigned rooms are designated accordingly. The room name is selected by tapping.

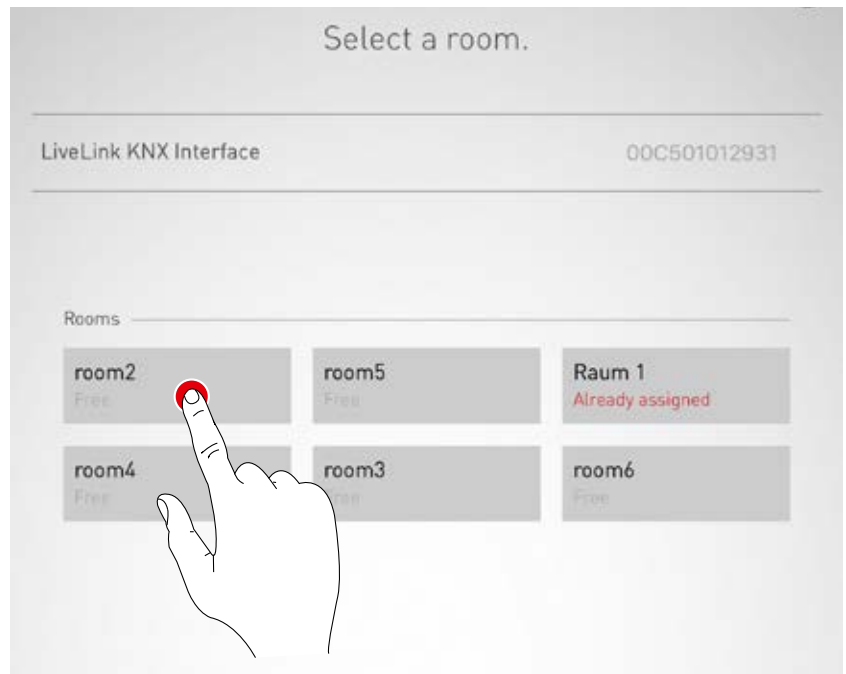

Modifying the KNX interface

Tap the symbol to modify the selected interface.

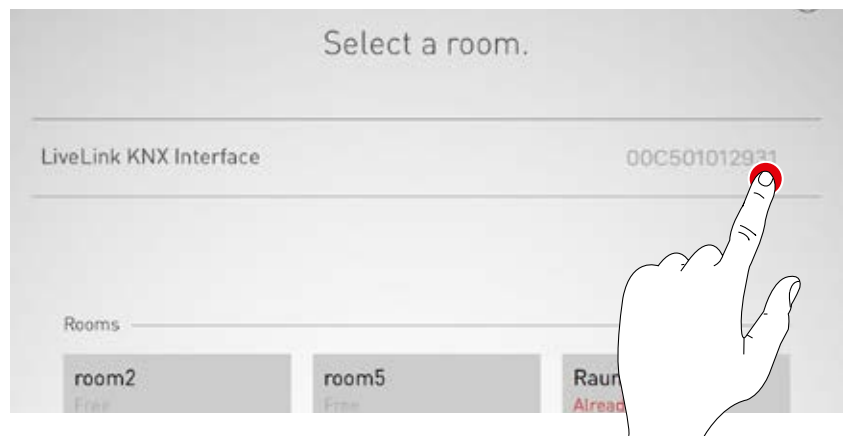

SETTING UP KNX: STEP 2

Link scenes

Available LiveLink scenes are listed with corresponding KNX scene numbers. Select the appropriate scene by tapping its Edit symbol.

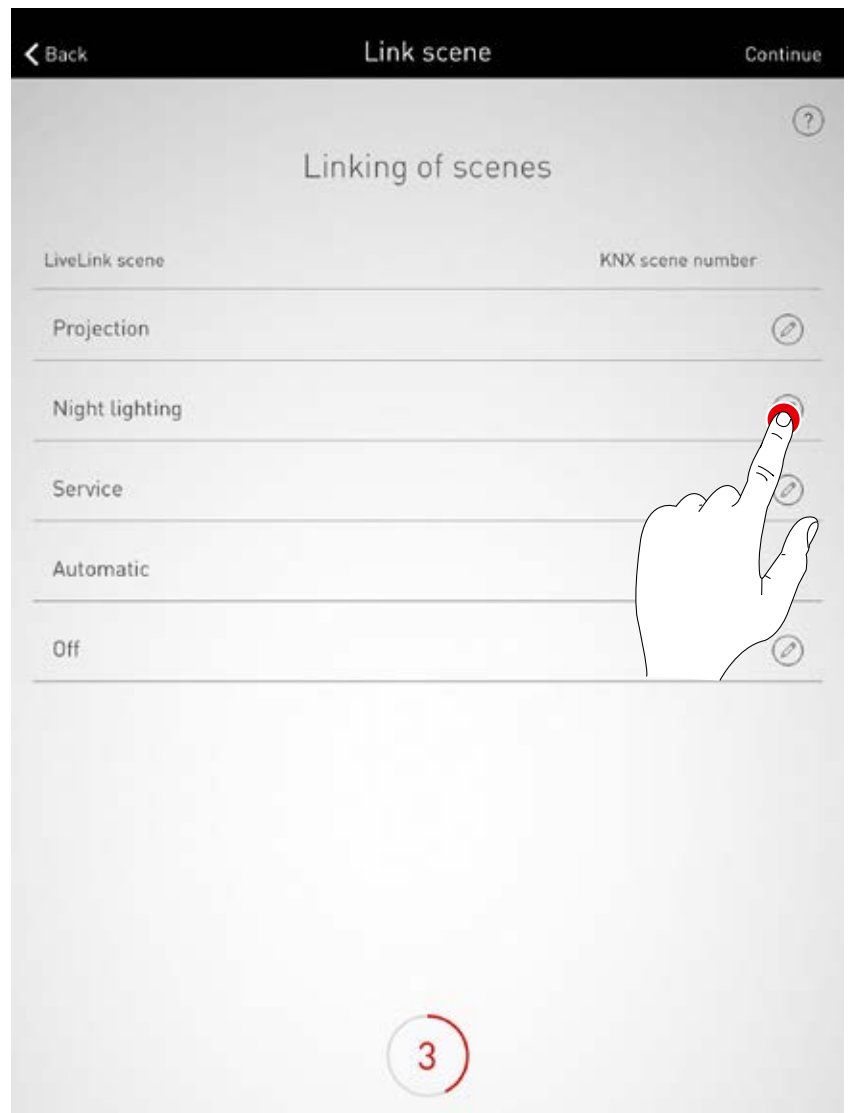

Link scenes

The KNX scene number saved in the system is entered here. Tap the confirm button to finalise scene linking.

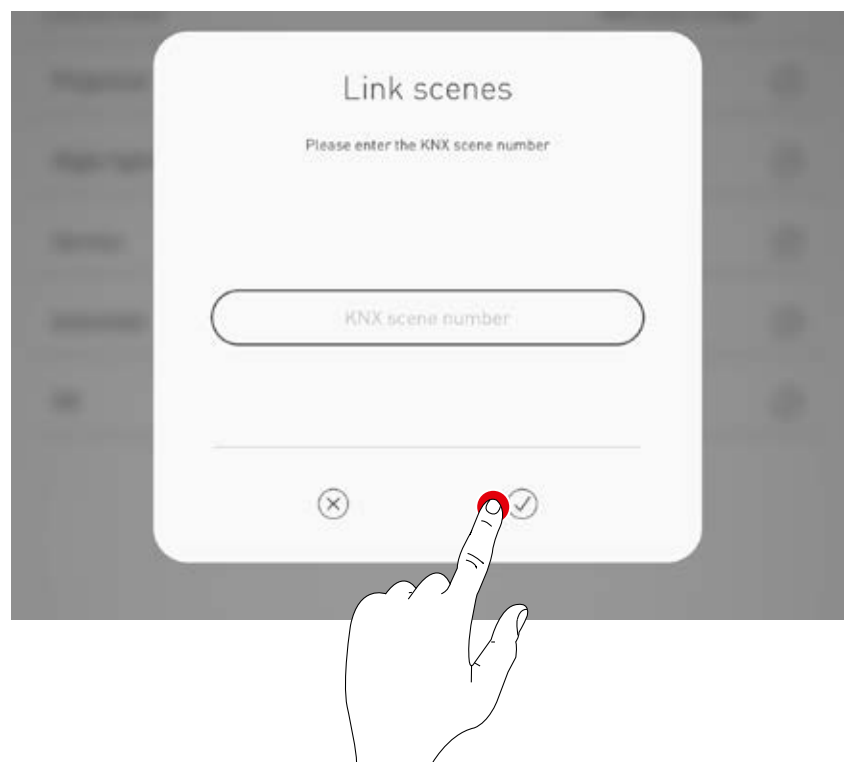

SETTING UP KNX: STEP 3

Link light groups

This view lists available KNX luminaire groups. Link these with a LiveLink luminaire group by tapping the Edit symbol.

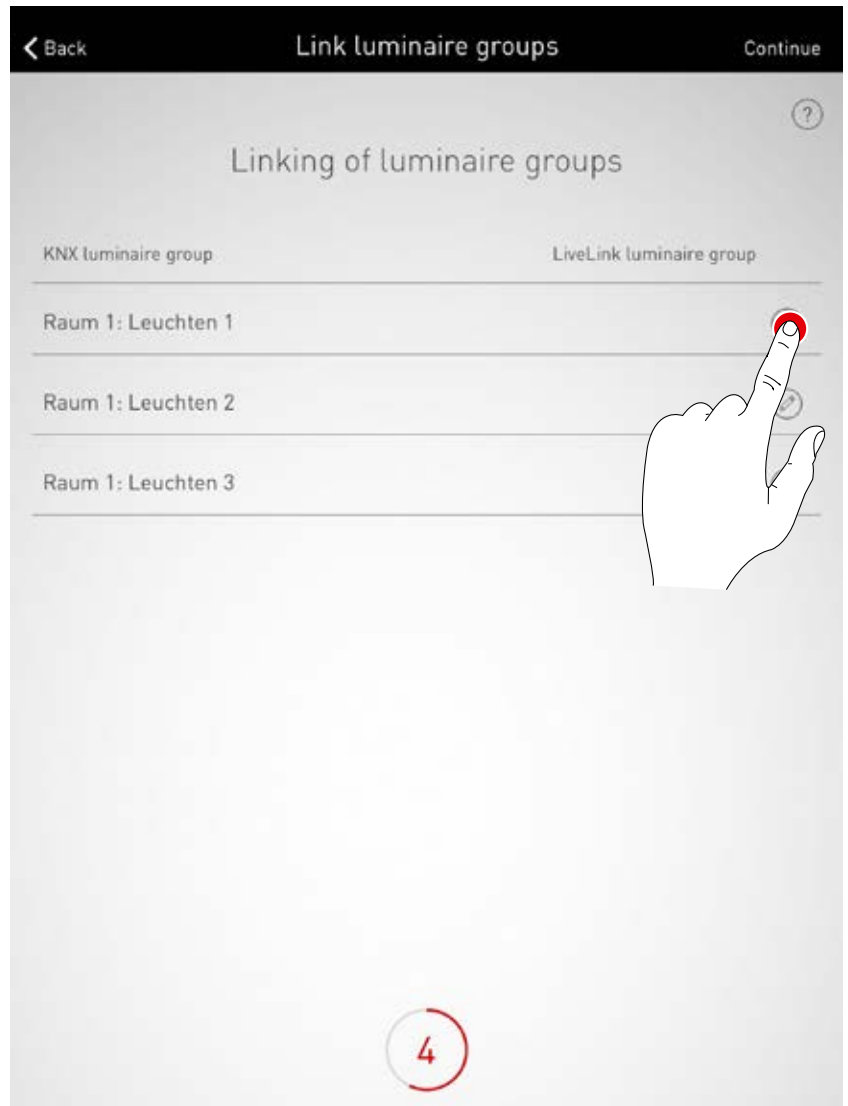

Link luminaire groups

Select the desired LiveLink luminaire group.

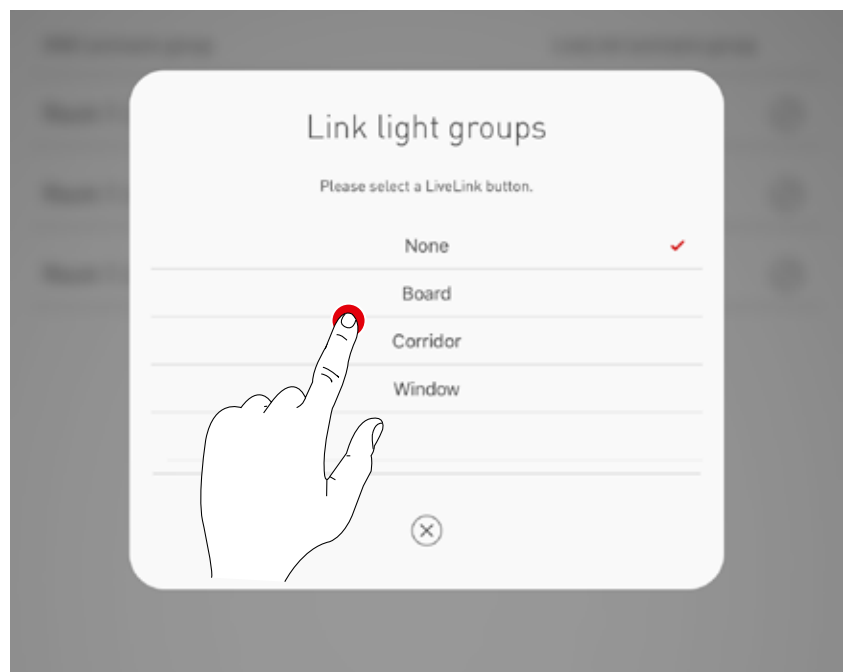

SETTING UP KNX: STEP 4

Link buttons

Push-buttons available in the KNX system are displayed here. Select the appropriate push-button by tapping the Edit symbol.

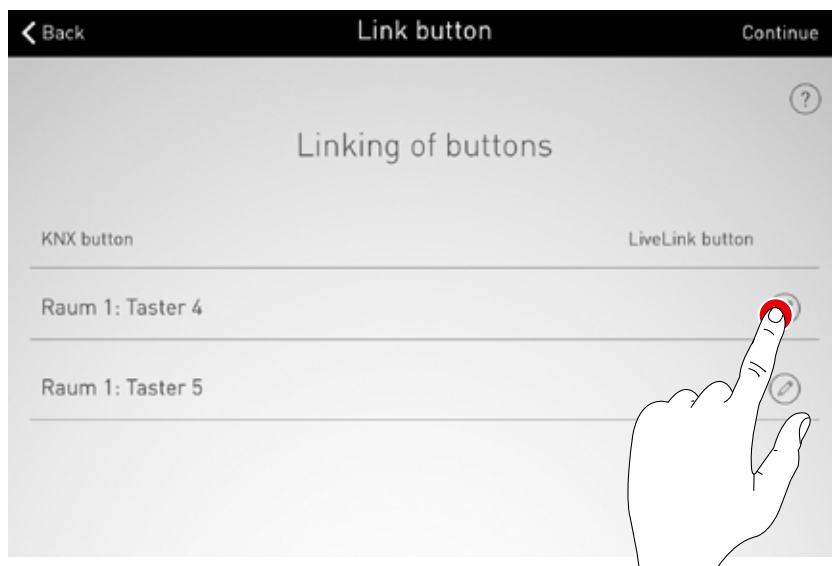

Link button

After selecting the KNX push-button, a window indicates that LiveLink waits for assignment of the button. The corresponding push-button must now be pressed and held (for up to 5 seconds) until the assignment is confirmed in the window

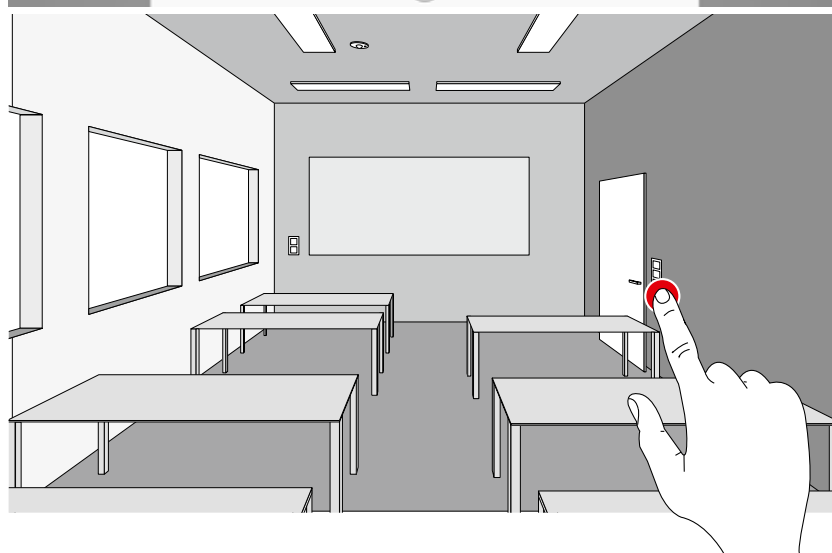
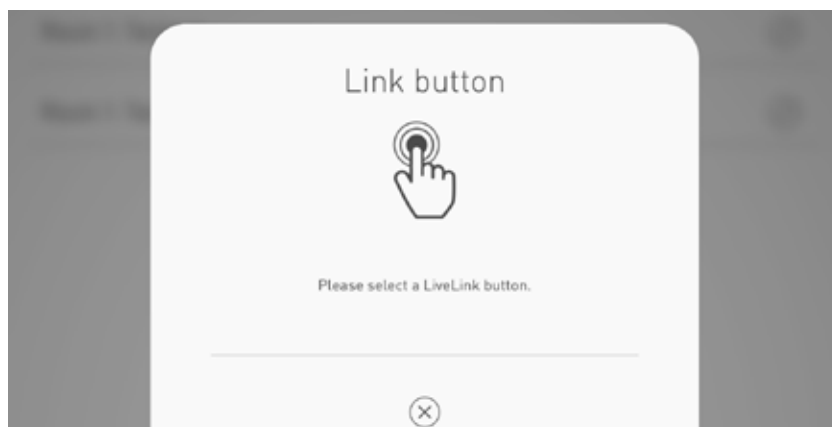

SETTING UP KNX: STEP 5

Link presence sensors

The available presence sensors in the KNX system are listed. Select the appropriate sensor by tapping its Edit symbol.

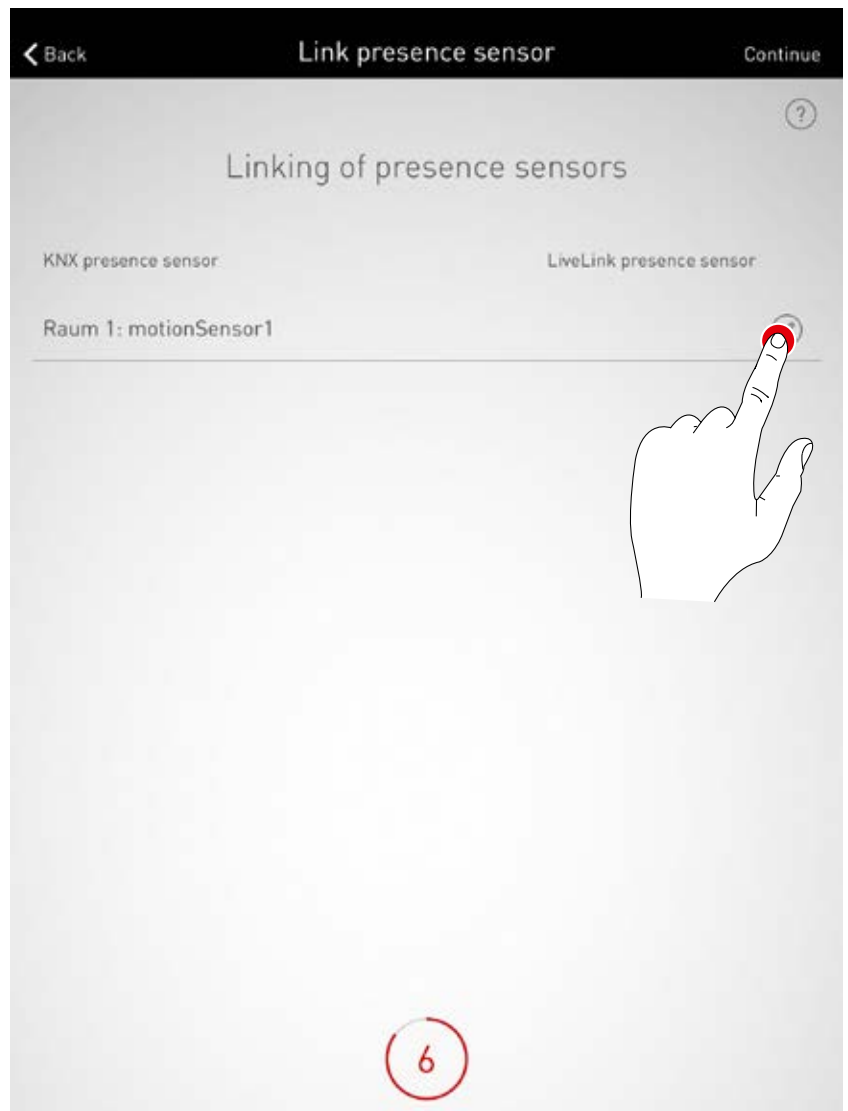

Link presence sensor

Tapping a LiveLink presence sensor finalises its linking.

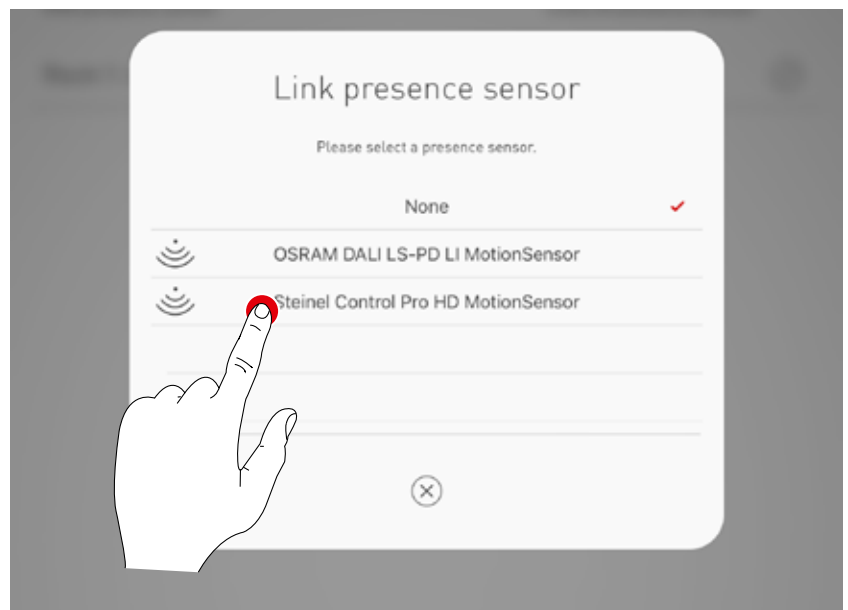

SETTING UP KNX: STEP 6

Link brightness sensors

Brightness sensors available in the KNX system are listed. Select the appropriate sensor by tapping its Edit symbol.

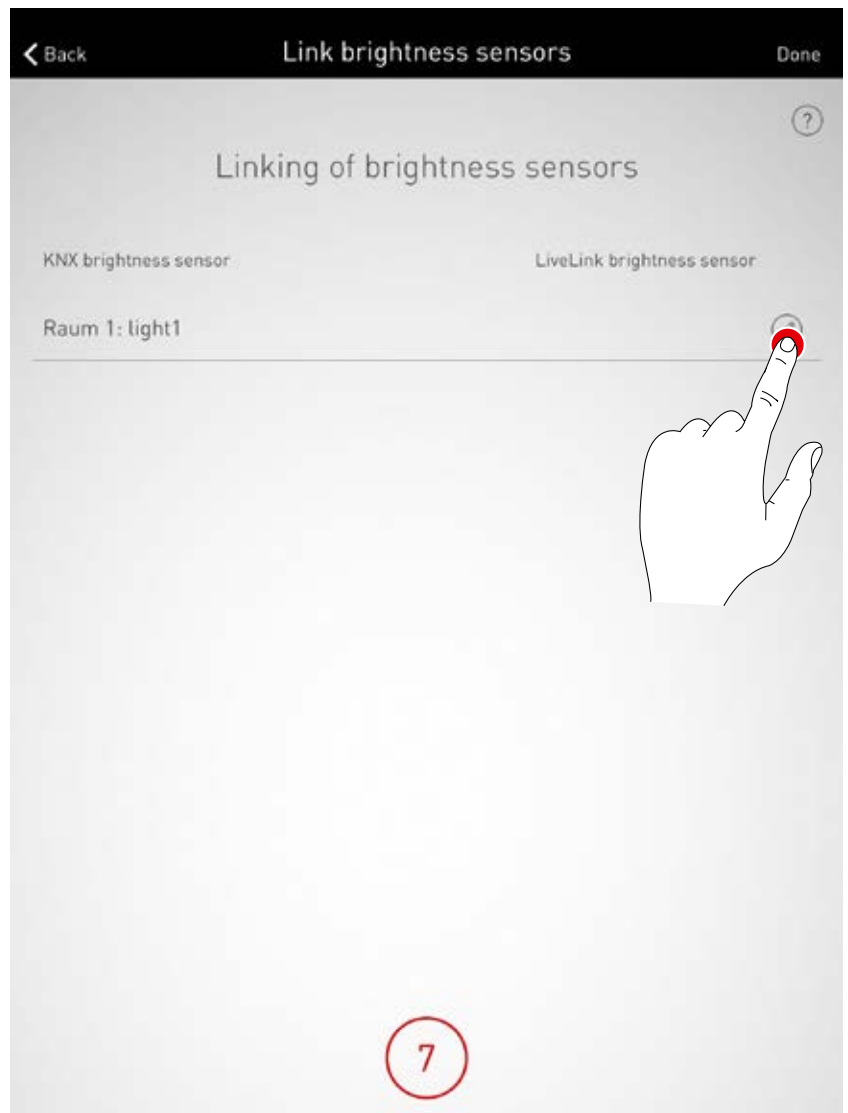

Link brightness sensors

Tapping a LiveLink brightness sensor finalises its linking.

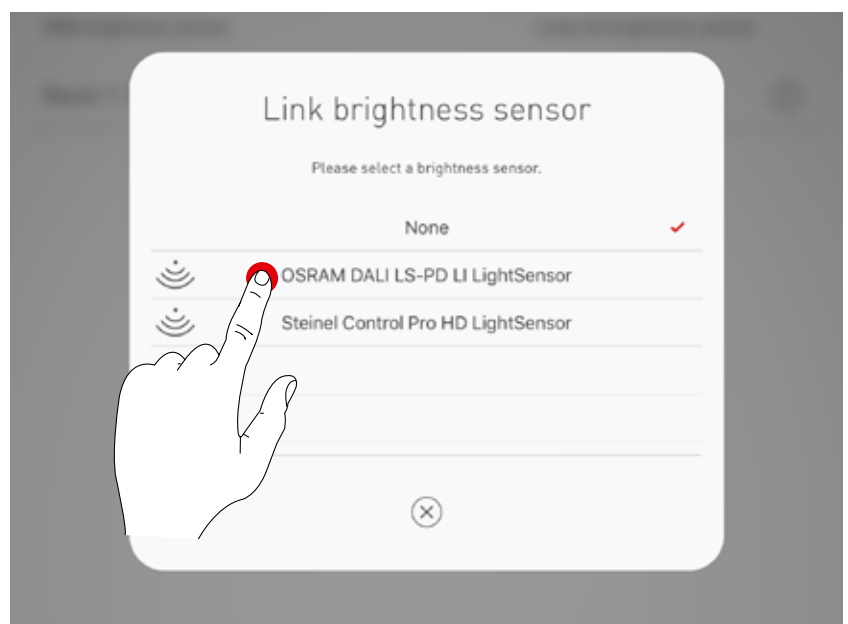

SETTING UP KNX

Check the summary and implement optional settings

The KNX setup can be checked in this view via the summary. Access the previous steps via the Edit symbols if modifications are needed. The KNX setup is finalised if no changes are required.

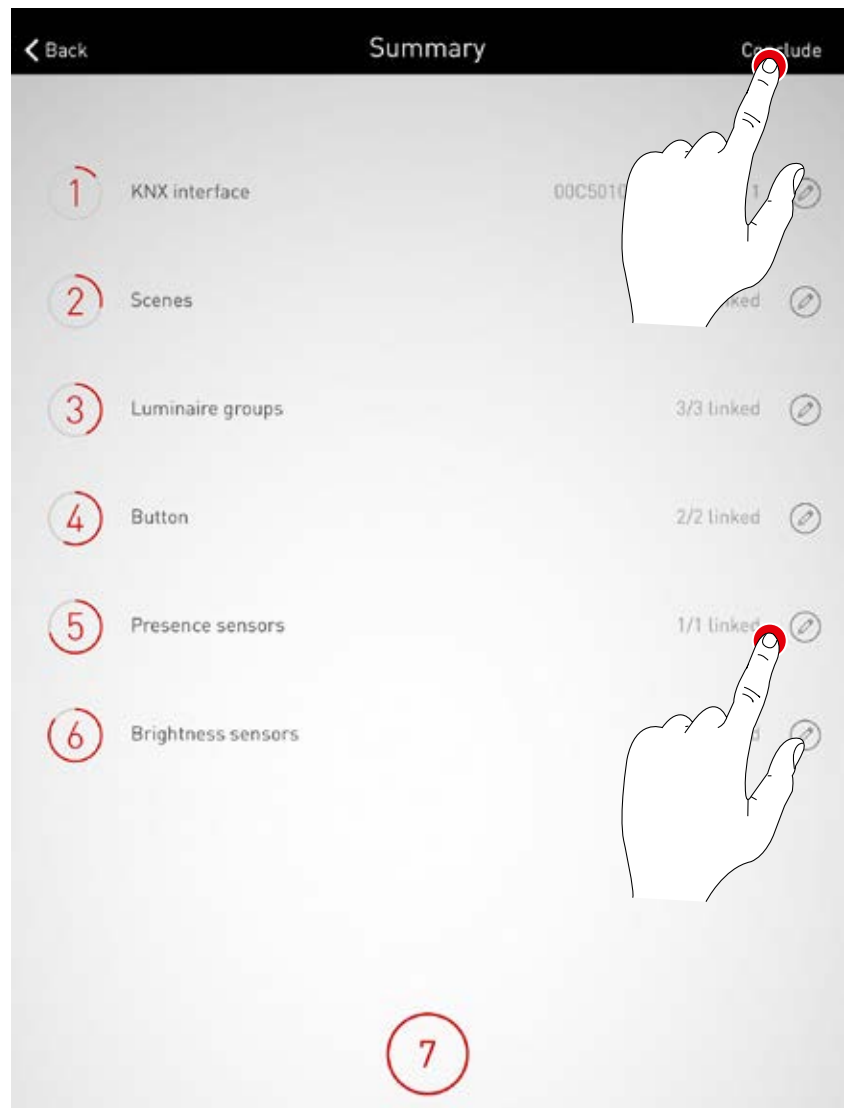

ROOM MANAGEMENT: GENERATE PDF

This function enables a system log to be exported as a PDF. This document can be used e.g. as an acceptance log following the commission process.

Project data

Project-specific data for the LiveLink setup is entered. The system settings are summarised automatically.

The screenshot shows a mobile application interface with a dark header bar containing a back arrow and the word "Summary". A white dialog box titled "Create PDF" is centered on the screen. It contains the following fields:

- Building name or reference number:
- Commissioned by:
- Acceptance by:
- Comment:

At the bottom of the dialog box, there are two circular icons: a close button (an 'X' in a circle) on the left and a confirmation button (a checkmark in a circle) on the right. A red line originates from the "Project data" text on the left and points to the "Building name or reference number" input field.

Select PDF generation

The optional "Generate PDF" function can be called in the LiveLink setup summary. Following completed room creation, this function is located in the Room management/Overview menu.

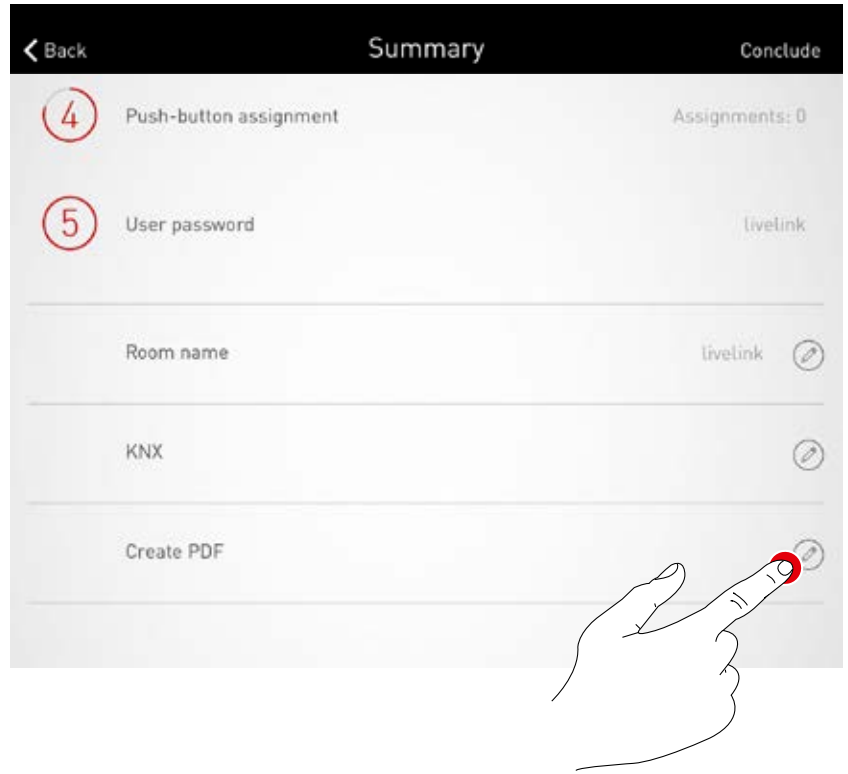

Enter project data

The project-specific data of the LiveLink setup is entered first. After acknowledging these entries, all system settings are collected and an acceptance log is generated with this project data



Export PDF

The acceptance log is displayed. The PDF is exported via the share button, e.g. sent via email.

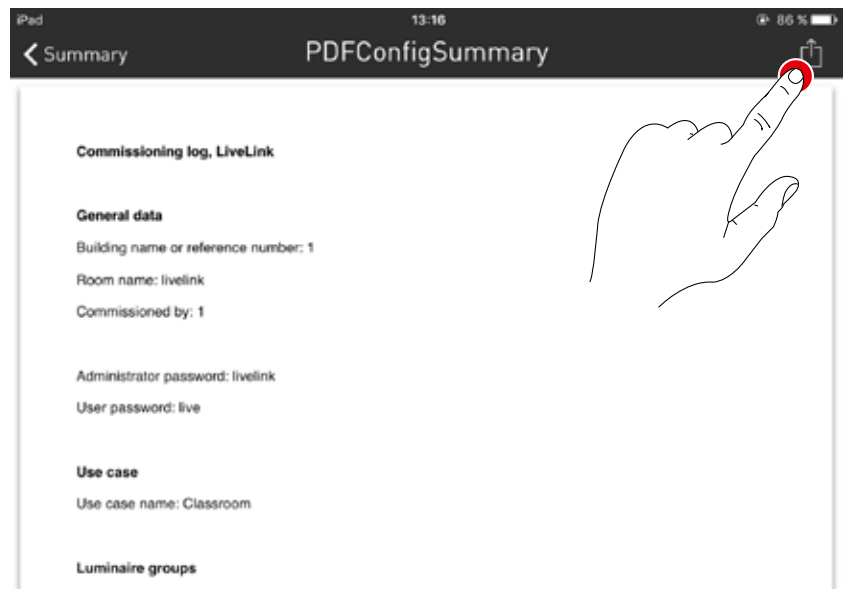

SETTINGS

The "Settings" screen in the administrator menu displays important system information and covers the basic settings of the LiveLink control device.

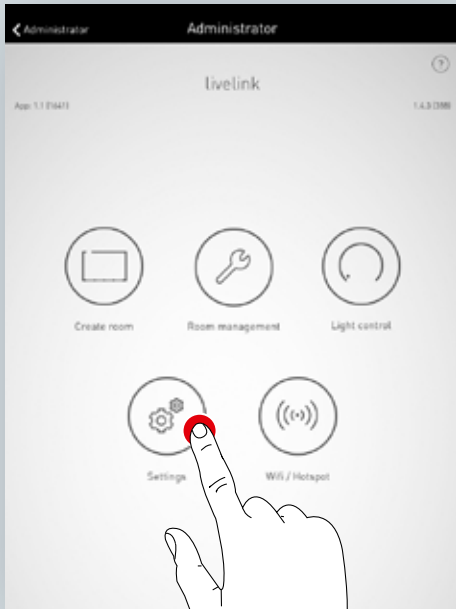

Information about the control device
Room name and firmware version

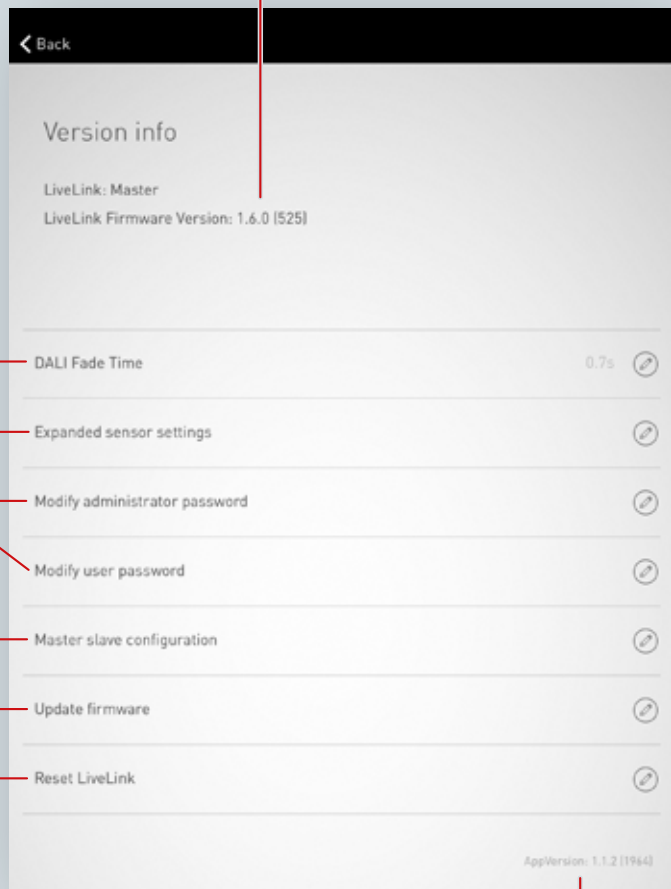

DALI fade time

Setting of the transition time between the dimming levels

Advanced sensor settings

Change password

for administrator account and user account

Master slave configuration

Setup of a control for (sports) halls with several „LiveLink WiFi Connect“ control units.

Update firmware

Update the operating software on the LiveLink control device

Reset LiveLink

to delivery condition

App version details

SETTINGS: DALI FADE TIME

The DALI fade time controls the transition time between the dimming levels. In the case of a setting of "0.0s", the brightness level will be changed without utilising dimming function. The longer the transition time, the softer the dimming process will appear to be.

To change the DALI fade time, the desired time can be selected by swiping vertically and subsequently stored by tapping on "Accept DALI fade time".

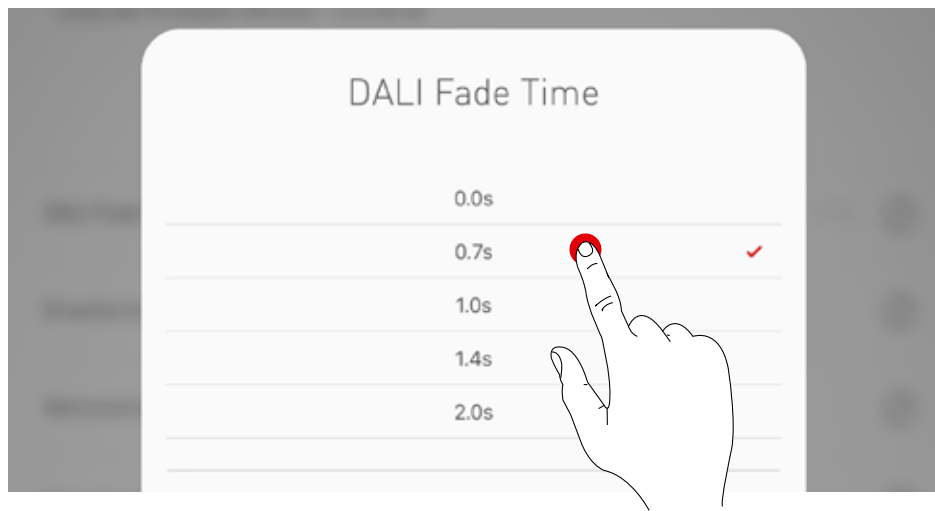
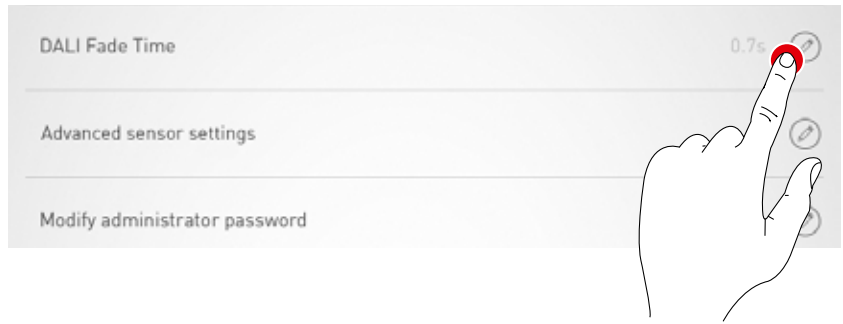

SETTINGS: RESET LIVELINK AND HARDWARE RESET

After tapping "Reset LiveLink" and subsequent confirmation, the LiveLink control device will be reset to its delivery condition.

Caution: All settings will be deleted!

After resetting, the LiveLink control unit is restarted. The WLAN is not available during this period.

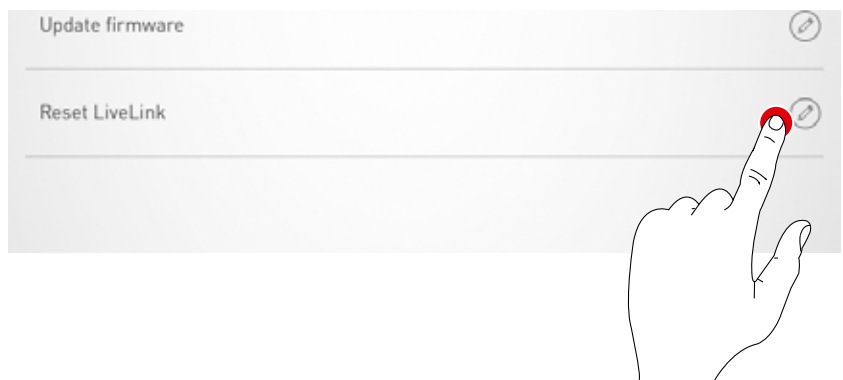

For a hardware reset, the DALI connections are short-circuited (connecting both DALI lines) and at the same time the internal push-button on the control device is held down for 20 seconds. For this, a push-button should be connected to the designated interface (S) on the LiveLink controller.

The LED flashes on the controller as confirmation when the hardware reset starts (and if the devices boots).

SETTINGS: ADVANCED SENSOR SETTINGS

Tapping on "Advanced sensor settings" provides access to detailed settings of the sensors. The functions that can be adjusted are dependent on the sensor used. Typical default values are already pre-set; in most cases, these do not need to be adjusted.

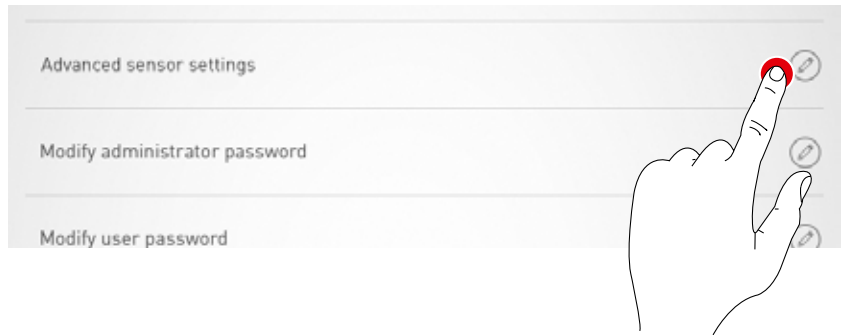

All sensors are listed. Here, the desired sensor can be selected.

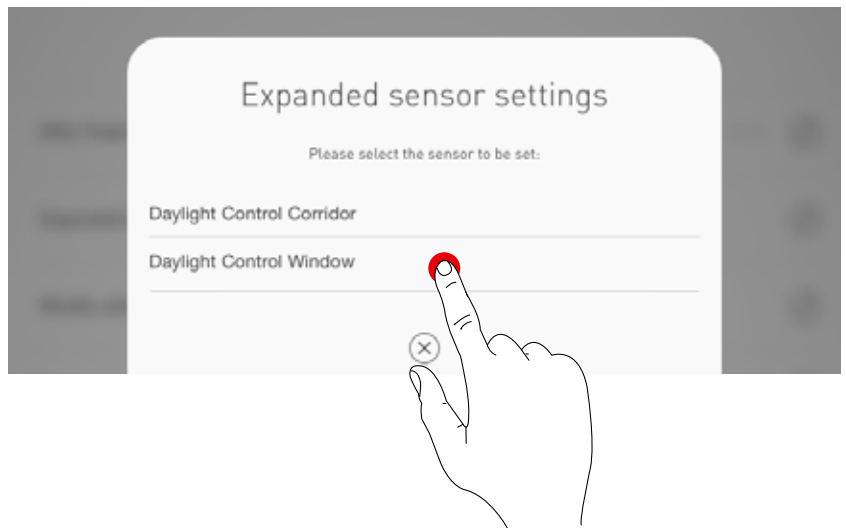

In this screen, the settings options for the sensor are listed.

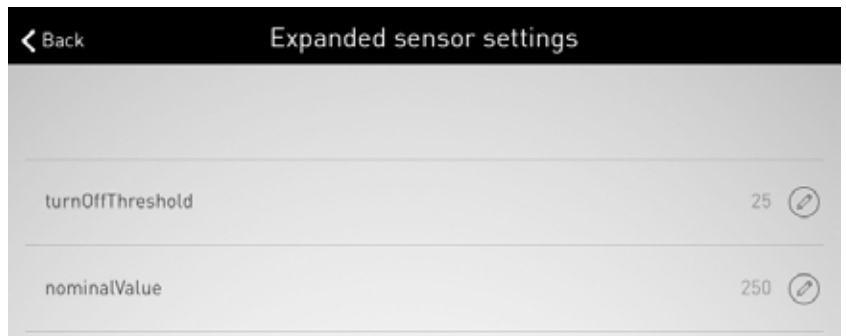

Subsequent to tapping on a sensor function, the value can be changed and stored. The different sensor functions are described in the table below.



	Parameter	Default setting	Variables	Explanation
Presence detection	Operating mode	-	Fully automatic/ Semi-automatic	Fully automatic: automatic switch-off and switch-on Semi-automatic: automatic switch-off, switch-on manually via push-button or app
	Switch-off time	5 minutes	0-60 minutes	Shut-off delay in minutes
	Inverse time	5 minutes	0-60 minutes (identical to switch-off time)	Inverse time of presence detection
	Start value without constant light	100 %	set in use case	If the regulation is switched on again via a presence sensor in "Light Mode", this is adopted as the start value.
Constant light control	Daylight switching behaviour	Auto off/on	1. Automatic switch off/on 2. Minimum, no switch-off 3. Switch-on inhibit	Switching behaviour in case of sufficient daylight
	Daylight switch-off time	900 seconds	Fixed time	Switch-off time with sufficient daylight (seconds)
	Switch-off threshold	25 %	Fixed value	Switch-off threshold with sufficient daylight (percent)
	Nominal value	500 lx	0-1024 lx	Nominal value (measured on sensor)
	Uncontrolled nominal value range	5	0-20	Range around the nominal value with no adjustment
	Adjustment steps around the nominal value	1	0-20	In steps around the nominal value
	Range with lower control adjustment	10	0-40	Other ranges with adjustment at lower speed
	Adjustment steps of other areas	3	0-20	Step width in other ranges
	Adjustment speed downwards	2	0-20	Speed of adjusting down
Adjustment speed upwards	0	0-20	Speed of adjusting up	

SETTINGS: UPDATE FIRMWARE

Tapping on “Update firmware” starts the update process of the operating software in the LiveLink control device.

The latest firmware is transferred from the app to the control device via Wi-Fi and installed on it. For this, no Internet connection is necessary.

Caution: The firmware is stored in the “LiveLink Install” app. To ensure that the latest firmware is being utilised, the app should be updated in advance. (Typical update process via the Apple App Store on iOS devices or the Google Play Store on Android devices; Internet connection required)

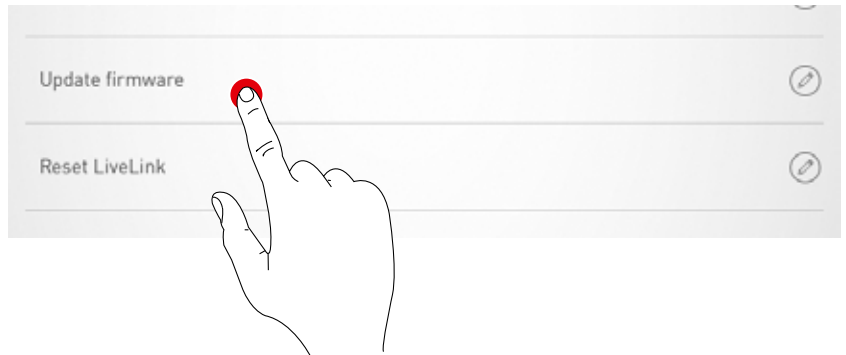

A window shows which version is currently installed and to which version an update can be performed.

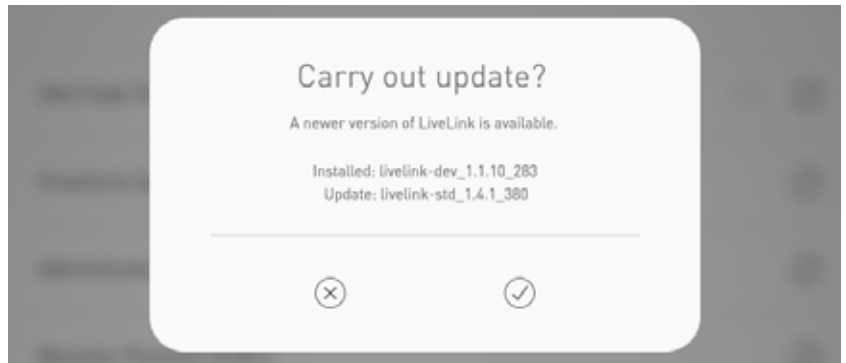

Upon confirmation, the firmware is uploaded to and subsequently installed on the control device ("LiveLink flashing").

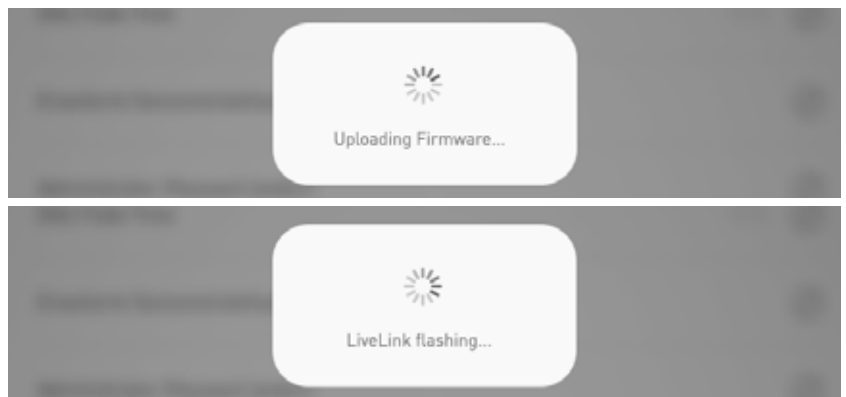

A window indicates that the update has been completed successfully. The system then restarts and the app then displays the room selection view again.

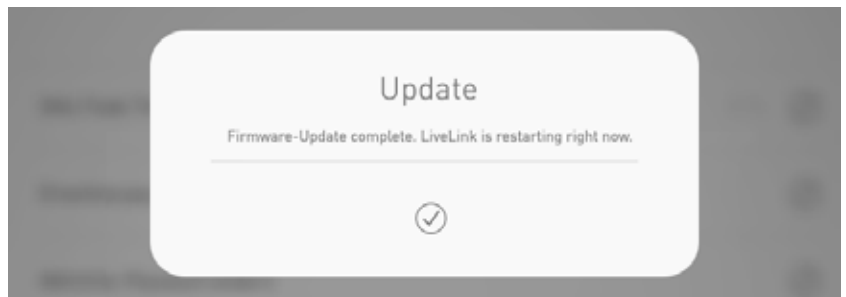

SETTINGS: CHANGE PASSWORDS

The administrator password and the user password can be changed at any time. The respective function is called up and the old password must be entered first. The new password must be entered twice.

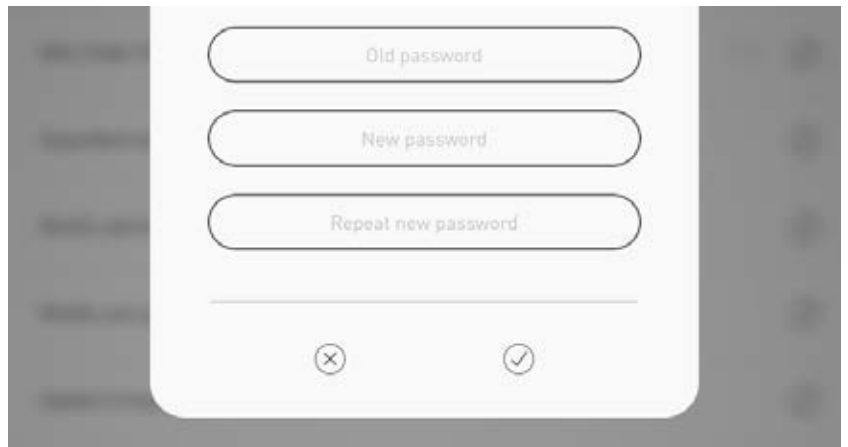
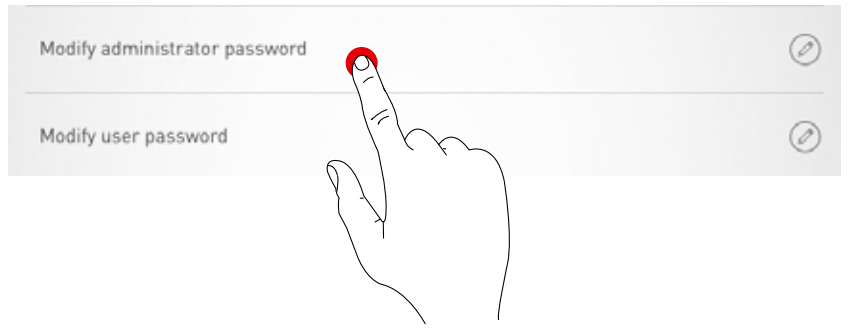

WLAN SETTINGS

The LiveLink control device can be connected to an existing local Wi-Fi network. The LiveLink room then is available on the existing network for configuration and operation.

The WLAN can also be deactivated if required. In this case a direct connection to LiveLink via WLAN is no longer possible and only becomes available again after restarting the LiveLink system.

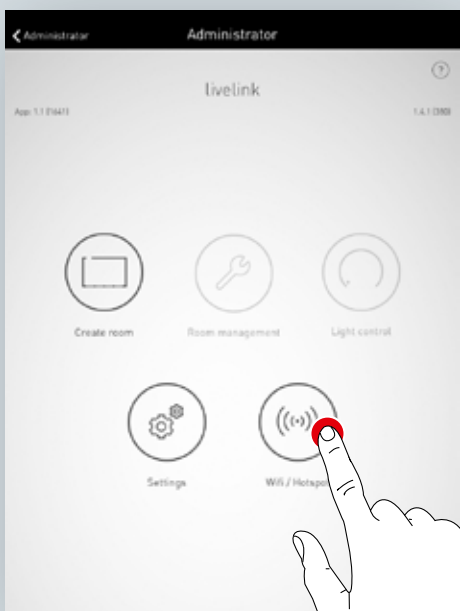

Deactivate WLAN

Connect with infrastructure

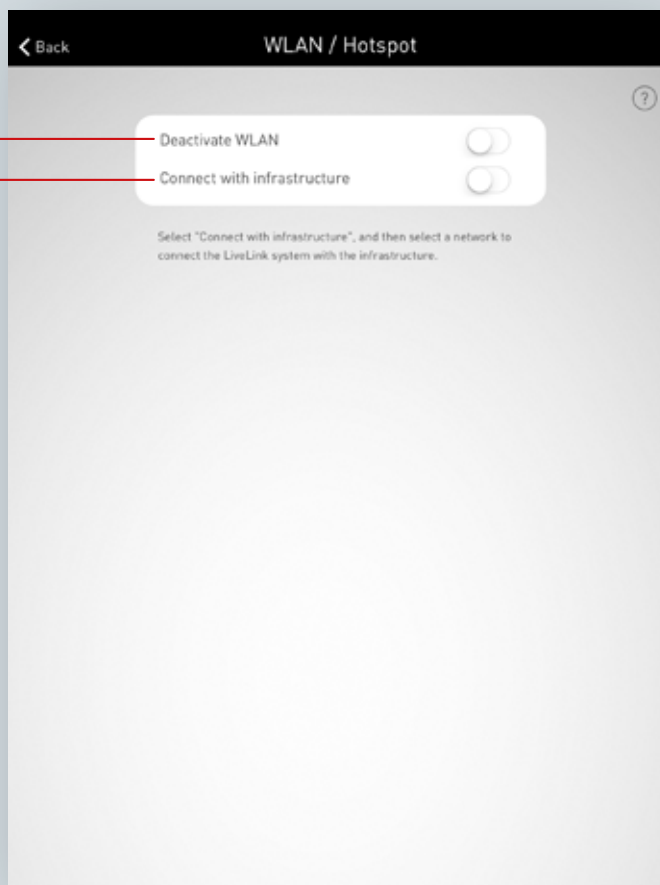

WLAN SETTINGS: CONNECT TO AN EXISTING LOCAL NETWORK

Technical requirements for the WiFi infrastructure

- **Encryption:** WPA/PSK, WPA2/PSK, WEP (not recommended)
- **WiFi standard:** 802.11bg
- **Frequency band:** 2,4 Ghz
- **Network:** DHCP or static IP
- **Port:** 8443 (not limited)
- The tablet and LiveLink must be located in the same subnet.

Technical basis for WLAN SSID

If an infrastructure connection is active the WLAN of the LiveLink control device is hidden (SSID broadcast is suppressed). The WLAN can still be used for service purposes. In this case the WLAN name must be manually entered for connection.

Switching on configuration of an existing local Wi-Fi network



Select network

All available Wi-Fi networks are listed. The desired Wi-Fi network is selected.

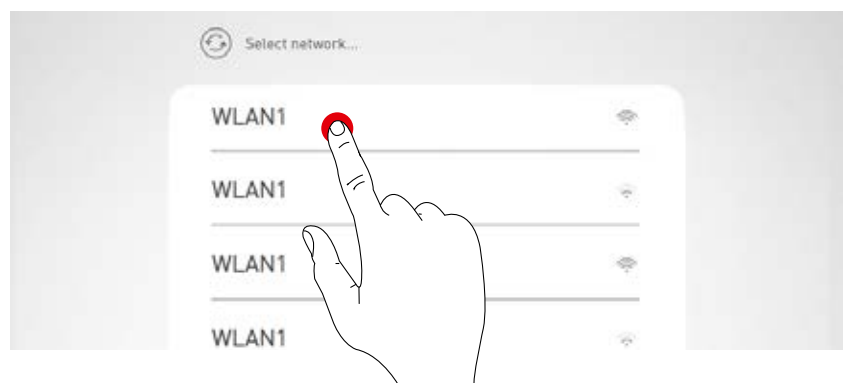

IP setting: dynamic (DHCP)

If the LiveLink control device is to be assigned an IP dynamically by the existing network (DHCP), the "static" tickbox should remain unticked..

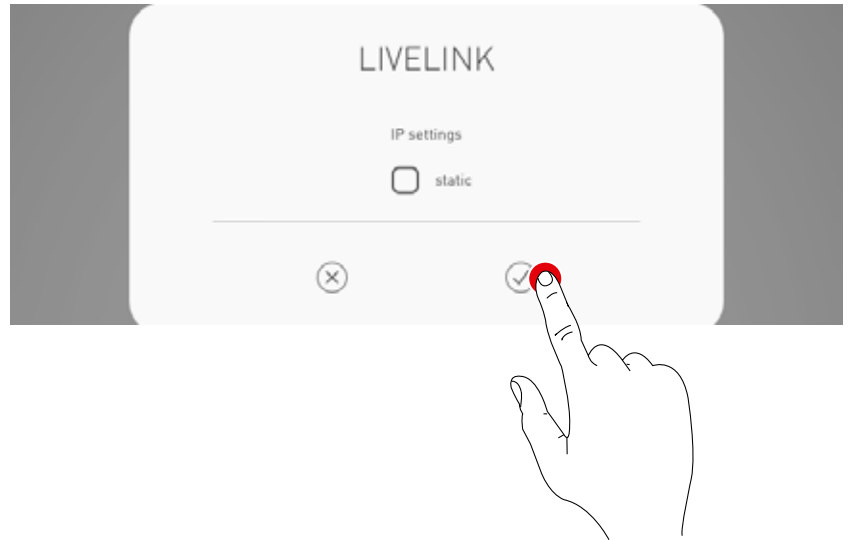

IP setting: static

Alternatively, static IP settings can be applied.

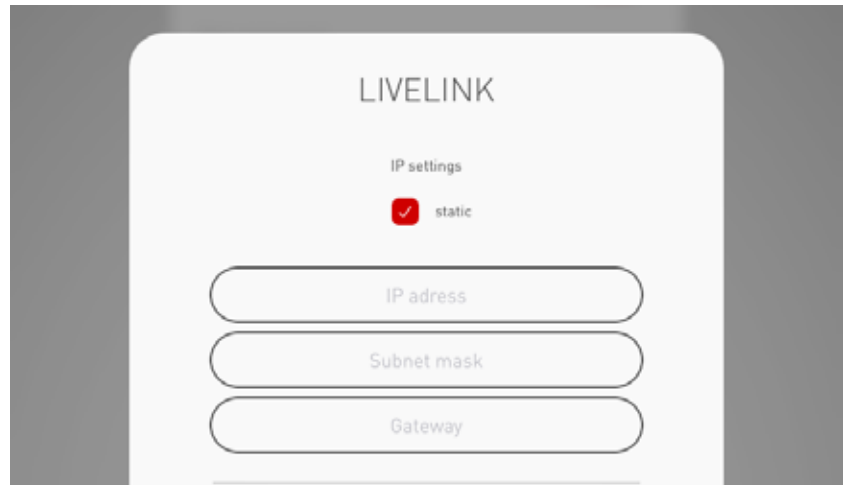

Enter the Wi-Fi password

Upon entering the password for the local Wi-Fi network the connection is established.

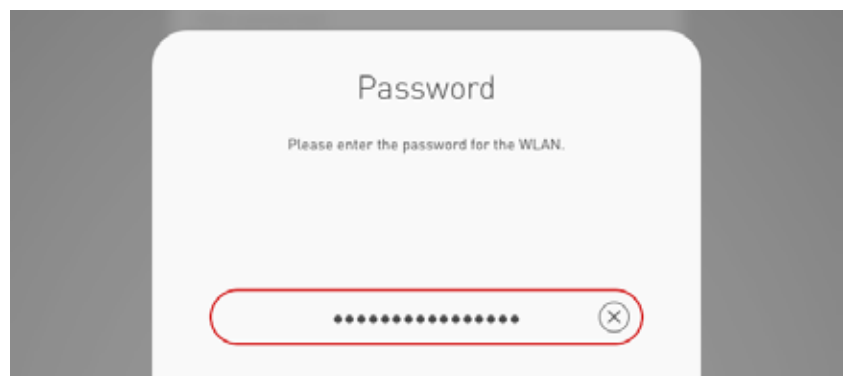

WLAN SETTINGS: WLAN DEACTIVATION

The WLAN can be deactivated following commissioning.

The WLAN switch-off function is located in the "WLAN/Hotspot" administrator menu.

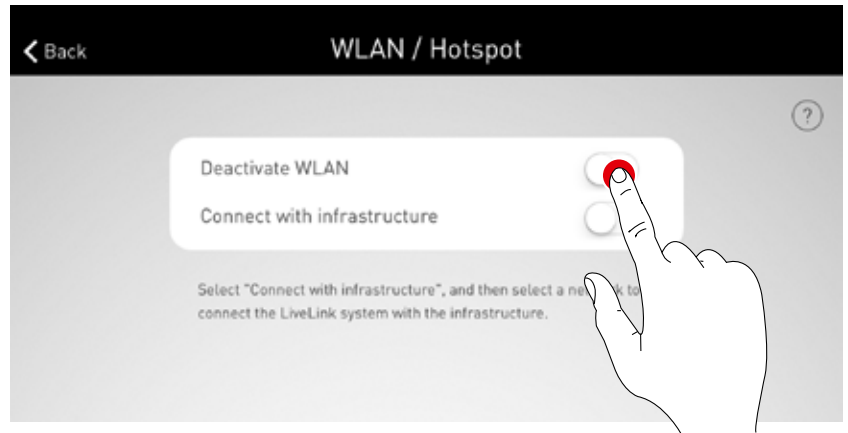

The deactivation in this pop-up must be confirmed. The WLAN switches off after 10 minutes.



REACTIVATING THE WLAN

If disconnecting the WLAN prevents access to the system, the control unit must be disconnected from the power supply. Following restart of the control unit, the WLAN becomes available again for 10 minutes. It is then possible to connect to the system via WLAN to e.g. remove deactivation of the WLAN. Following power-up and selection of the room, the user is informed of this via a pop-up.



OPERATING THE LIGHT CONTROL

The light control of the already selected room can be called up directly in the administration menu of the "LiveLink Install" app. The operation is identical to the functionality of the "LiveLink Control" app; see corresponding chapter for the app.

Caution: The light control can be selected only if the room has already been completely set up.

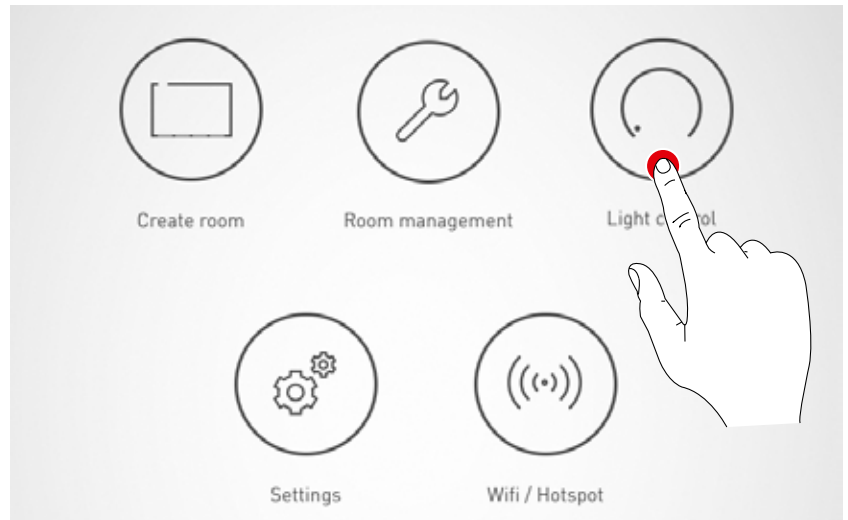

"LIVELINK CONTROL" APP

OVERVIEW

The completely set up system can be controlled via the LiveLink apps. The user is able to dim, switch on and switch off individual luminaire groups or the whole system. In addition, previously created scenes can be selected.

The light control is operated via the "LiveLink Control" app, but can also be carried out via the "LiveLink Install" app.

Back to room selection

Administrator

Help

Set the luminaires in the room

Dimming of the selected luminaire group

Switching on/off of the selected luminaire group

Select all luminaires
Selects all luminaires for light control.

Select individual luminaire groups
Allows individual luminaire groups to be selected and controlled separately. In case of numerous luminaire groups, you can navigate to the desired luminaire group by swiping.

Selected luminaire group

Current status
Displays the current switching state and dimming value.

Light scenes
List of all light scenes. Tapping on a scene activates the respective lighting setting. In case of numerous scenes, you can navigate through the list by swiping.

Scenes

Night lighting	Projection	Off
Service	Break	Automatic

SELECT ROOM

When the app is started, the "Select room" view is already active. The app searches for LiveLink rooms on the network.

The desired room can be located by swiping and can subsequently be selected.

Caution: The tablet and/or smart phone must be connected to the LiveLink control device via Wi-Fi. Either directly to the control device's Wi-Fi or to an existing Wi-Fi network (see chapter "Wi-Fi")

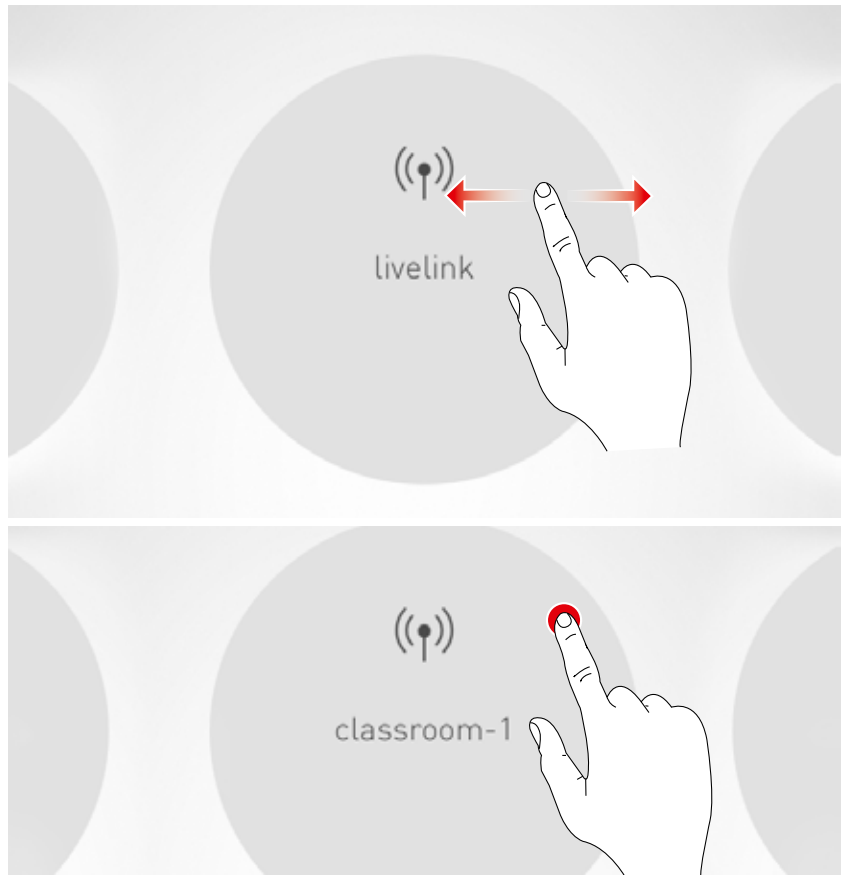

MANUAL SETTING OF THE ROOM LIGHTING

Select a luminaire group

First, a luminaire group should be selected for which the lighting settings are to be changed. In case of numerous luminaire groups, you can navigate by swiping. For each luminaire group the current state and dimming level are displayed. Pressing the "All" button, will select all the luminaire groups.

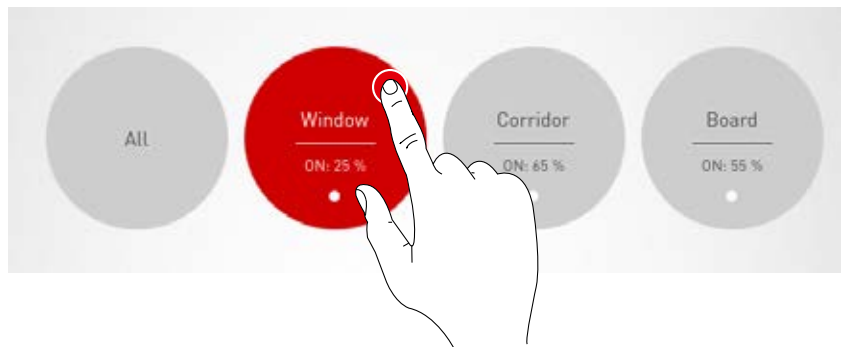
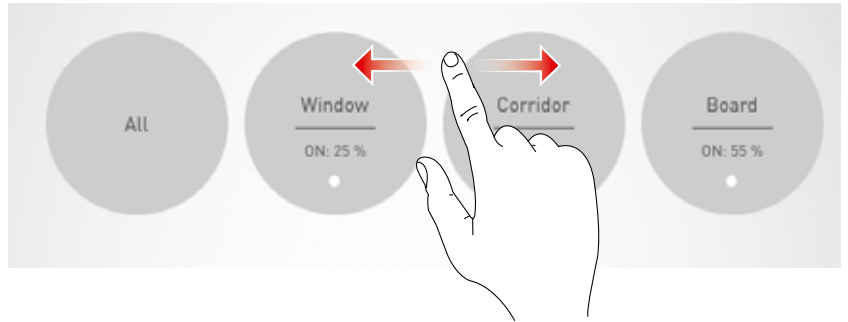

Switching a luminaire group on/off

The currently selected luminaire group and the dimming value are displayed in the control wheel. By tapping the on/off button, the luminaire group is switched on (red symbol) or switched off (grey symbol).



Dimming a luminaire group

A dimming value for the active luminaire group is specified via the control wheel.

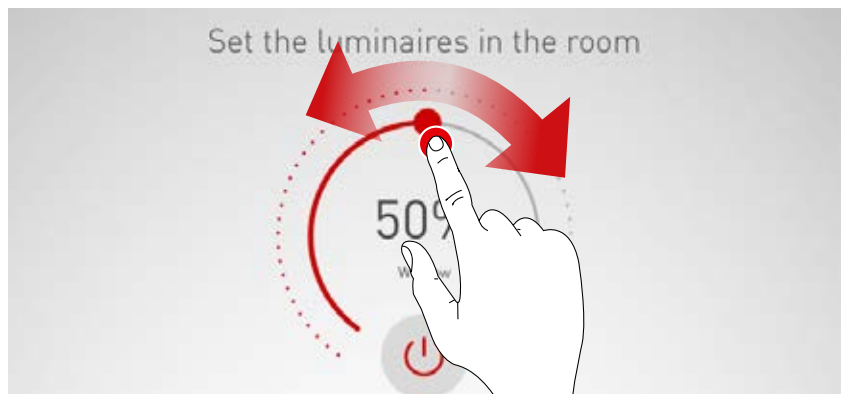

ACTIVATING LIGHTING SCENES

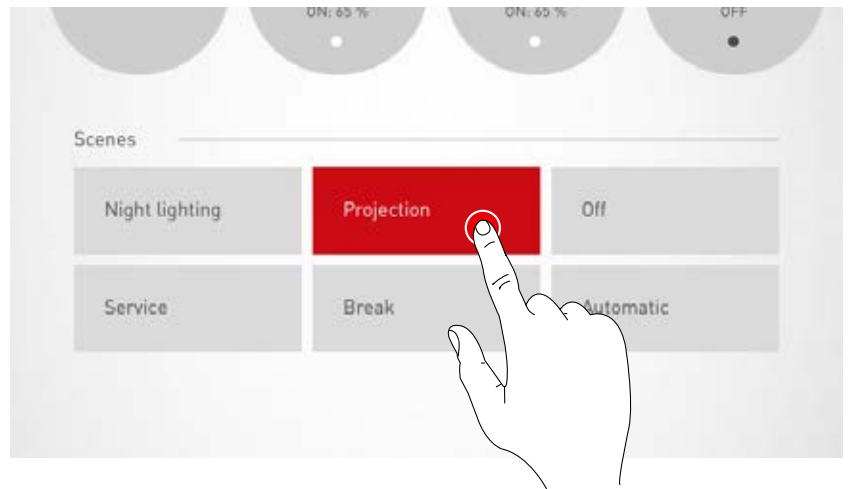

Previously created lighting scenes can be activated from the list in the lower area of the view. The scene is activated by tapping on the respective button. It is then highlighted in red and marked with a tick.



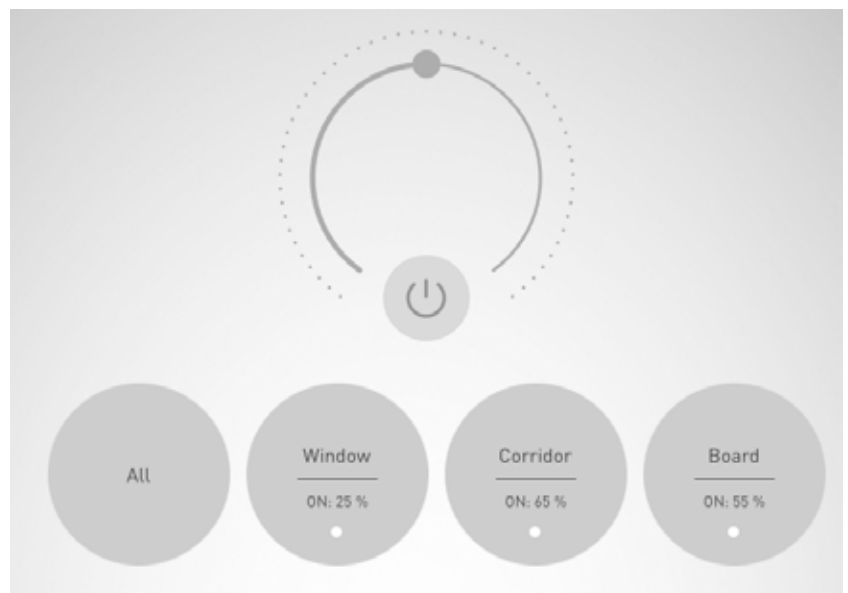

The current state of illumination is displayed; however, the operating fields of the manual light control are depicted grey. Once the lighting scene has been activated, a manual intervention can be carried out immediately; for this, see the chapter "Manual setting of the room lighting".



ORDER DATA

	Reference	Description	TOC
Controller			
	LiveLink WiFi	LiveLink control unit with DALI output for controlling up to 64 DALI devices, with integrated WLAN module for commissioning and control via tablet or smartphone, includes mounting clips for VDE-compliant connection in ceilings or cavity walls.	6565400
Sensor			
	LiveLink Sensor IR Quattro HD	PIR room sensor for daylight-dependent control and presence detection (for installing in ceiling, mounting height 2.5m to 10m, square detection zone: 8x8m to 20x20m), connection to LiveLink system via DALI line, occupies 3 DALI devices	6565500
	LiveLink Sensor IR Quattro Slim XS	PIR room sensor for daylight-dependent control and presence detection (for installing in ceiling, mounting height 2.5m to 4m, square detection zone of 4x4m), connection to LiveLink system via DALI line, occupies 2 DALI devices.	6906200
	LiveLink Sensor IR Micro 01	PIR mini sensor for daylight-dependent control and presence detection (installed in the ceiling, mounting height 2.5m to 4m, square detection range of 4x4m to 6x6m diameter), connection to LiveLink system via DALI line, occupies 2 DALI devices – assembled in luminaires on request.	6906300
	LiveLink Sensor Dual HF	HF corridor sensor for daylight-dependent control and presence detection (for installing in ceiling, mounting height 2.5m to 3.5m, consists of two integrated HF sensors for detecting both corridor directions in corridors, detection range per sensor: 3x3m to 10x3m), connection to LiveLink system via DALI line, occupies 8 DALI devices.	6565600
	LiveLink Sensor IS 3360 MX Highbay	PIR highbay sensor for presence detection (for installing to ceiling, mounting height 3m to 14m, round detection range of max. Ø36m), connection to a LiveLink system via the DALI line, occupies 3 DALI devices.	6781000
	LiveLink Sensor IS 345 MX Highbay	PIR highbay sensor for presence detection in racking aisles (for installing in ceiling, mounting height 4m to 14m, oval detection range of max. 30x4m), connection to a LiveLink system via the DALI line, occupies 3 DALI devices.	6781100
Accessories			
	LiveLink DALI PB4	Push-button coupler for connecting up to 4 standard installation push-buttons, freely definable button functions, connection to LiveLink system via DALI line, occupies 1 DALI device.	6565200
	LiveLink Sensor AP BOX	Ceiling installation set for surface-mounting IR Quattro HD and Dual HF sensors, IP54.	6565700
	LiveLink Sensor BSK	Ball protection guard for IR Quattro HD and Dual HF sensors.	6565800
	LiveLink KNX Interface	KNX interface for integrating into KNX building control, rail-mounted device (2 sub-units), integration of up to 5 LiveLink control units via WLAN, equipped with KNX bus terminal and LAN RJ-45 jack.	6781200
	LiveLink ZREG	Cap rail adapter set consisting of two universal mounting brackets for installing the LiveLink control unit to a DIN cap rail.	7006700
	LiveLink Use Case	Individual use case with project-specific room configuration.	6912000

	Reference	Description	TOC
Kits			
	LiveLink Room Kit Standard	Standard room package consisting of LiveLink control unit and IR Quattro HD room sensor for energy saving in small to mid-sized offices.	6566100
	LiveLink Room Kit Comfort	Comfort room package consisting of LiveLink control unit, push-button coupler and IR Quattro HD room sensor for energy saving in e.g. classrooms and conference rooms, with additional scene control via standard installation push-buttons.	6566200
	LiveLink Corridor Kit	Corridor package consisting of LiveLink control unit and Dual HF corridor sensor, for energy saving in corridors with optional basic lighting upon absence.	6566300

TRILUX GmbH & Co. KG

Heidestraße · D-59759 Arnsberg
Postfach 19 60 · D-59753 Arnsberg
Tel. +49 29 32.3 01-0
Fax +49 29 32.3 01-3 75
sales@trilux.com · www.trilux.com

TRILUX LIGHTING LIMITED

TRILUX HOUSE, Winsford Way
Boreham Interchange
Chelmsford, Essex
CM2 5PD
Tel. +44 12 45.46 34 63
Fax +44 12 45.46 26 46
info.co.uk@trilux.com · www.trilux.com